

QS1 Fire Alarm Control Panel Technical Reference Manual

P/N 3100184 • Rev 2.0 • 12JUL01

Compliance Statement

The QS1, hereinafter referred to as the FACP or control panel, when properly installed, operates as a Local Protected Premises Fire Alarm System in accordance with the following standards:

- NFPA Standard 72, 1999 Edition
- Underwriters Laboratories Standard 864, 7th Edition
- Underwriters Laboratories of Canada Standard ULC S527

In addition, Auxiliary Fire Alarm System operation requires a Reverse Polarity Module (RPM). Central Station Fire Alarm System operation requires a Dialer card (DLD).

Installation in accordance with this manual, applicable codes, and the instructions of the authority having jurisdiction is mandatory.

Limitation of Liability

Edwards Systems Technology (EST) shall not under any circumstances be liable for any incidental or consequential damages arising from loss of property or other damages or losses owing to the failure of EST products beyond the cost of repair or replacement of any defective products. EST reserves the right to make product improvements and changes to product specifications at any time.

While every precaution was taken during the preparation of this document to ensure its accuracy, EST assumes no responsibility for errors or omissions.

Fire Alarm System Limitations

Automatic fire alarm systems can not guarantee against property damage, loss of property, or loss of life. An automatic fire alarm system's ability to provide early warning of a developing fire may be limited for a variety of reasons, but mainly due to improper installation or maintenance.

The best way to minimize system failures is to perform regularly scheduled preventive maintenance in accordance with national and local fire codes. All system components and wiring should be tested and maintained by trained fire alarm system professionals.

FCC Compliance Statement

This equipment can generate and radiate radio frequency energy. If this equipment is not installed in accordance with this manual, it may cause interference to radio communications. This equipment has been tested and found to comply within the limits for Class A computing devices pursuant to Subpart B of Part 15 of the FCC Rules. These rules are designed to provide reasonable protection against such interference when this equipment is operated in a commercial environment.

Operation of this equipment is likely to cause interference, in which case the user at his own expense, will be required to take whatever measures may be required to correct the interference.

	About this manual • iii
	Related documentation • iv
	Document history • vi
Chapter 1	Product description • 1.1
	System overview • 1.2
	Component descriptions • 1.3
	Circuit descriptions • 1.4
	Controls and indicators • 1.7
	Controls and indicators behind the flip-down cover • 1.8
	Controls and indicators on the zone annunciator card • 1.9
	Interpretation of screen displays • 1.10
Chapter 2	Installation • 2.1
	Installation do's and don'ts • 2.2
	Installation checklist • 2.3
	Two ways to install the cabinet: Surface or semi-flush mount • 2.4
	How to assemble the panel • 2.5
	Wiring mains ac and earth ground • 2.6
	System jumper settings • 2.7
	System addressing • 2.9
	Terminal definitions • 2.12
	Connecting a PT-1S printer • 2.18
	Installing standby batteries • 2.19
Chapter 3	Operating instructions • 3.1
	Instructions for the Level 1 operator (public mode access) • 3.2
	Instructions for the Level 2 operator (emergency mode access) • 3.5
	Instructions for the Level 3 operator (maintenance mode access) • 3.7
	Instructions for the Level 4 operator (service mode access) • 3.10
	QuickReference list • 3.11
Chapter 4	Programming instructions • 4.1
	Overview • 4.2
	QuickStart setup instructions • 4.4
	Customizing the system configuration • 4.12
	Setting up an Output Group • 4.19
	Setting up a Zone • 4.24
Chapter 5	Standard applications • 5.1
	Notification appliance circuits • 5.2
	Initiating device circuits • 5.4
	Coded alarm signaling • 5.6
	Remote station protective signaling system • 5.8
	Auxiliary protective signaling • 5.10

Content

Chapter 6

Maintenance instructions • 6.1

Pseudo point definitions • 6.2

Maintenance tasks • 6.7

Appendix A

System calculations • A.1

Notification appliance circuit maximum wire length calculation • A.2

Signature loop maximum wire length calculations • A.3

Battery calculation worksheet • A.8

Appendix B

Barcode library • B.1

Appendix C

SIGA-REL programming • C.1

Application block diagram • C.2

Programming instructions • C.3

About this manual

Organization

This manual provides information on how to properly install, wire, and maintain the FACP and related components, and is organized as follows:

Chapter 1 provides a detailed description of the fire alarm control panel and its operation.

Chapter 2 provides instructions for installing the fire alarm control panel.

Chapter 3 provides instructions for operating the control panel.

Chapter 4 provides instructions for programming the fire alarm system from the front panel.

Chapter 5 provides simplified wiring schematics for standard applications.

Chapter 6 provides instructions for maintaining the system.

Appendix A provides worksheets for calculating maximum wire lengths for notification and Signature circuits, and for sizing standby batteries.

Appendix B provides a set of bar codes that you can use to enter text for location messages.

Appendix C provides information on how to program the SIGA-REL using the QS-CU (QuickStart Configuration Utility).

Safety information

Important safety admonishments are used throughout this manual to warn of possible hazards to persons or equipment.

WARNING: Warnings are used to indicate the presence of a hazard which will or may cause personal injury or death, or loss of service if safety instructions are not followed or if the hazard is not avoided.

Caution: Cautions are used to indicate the presence of a hazard which will or may cause damage to the equipment if safety instructions are not followed or if the hazard is not avoided.

Related documentation

National Fire Protection Association

1 Batterymarch Park
P.O. Box 9101
Quincy, MA 02269-9101

NFPA 70 National Electric Code
NFPA 72 National Fire Alarm Code
NFPA 11 Low-Expansion Foam Systems
NFPA 11A Medium- and High-Expansion Foam Systems
NFPA 12 Carbon Dioxide Extinguishing Systems
NFPA 13 Sprinkler Systems
NFPA 15 Water Spray Fixed Systems for Fire Protection
NFPA 16 Deluge Foam-Water Sprinkler and Foam-Water Spray Systems
NFPA 17 Dry Chemical Extinguishing Systems

Underwriters Laboratories, Inc.

333 Pfingsten Road
Northbrook, IL 60062-2096

UL 38 Manually Actuated Signaling Boxes
UL 217 Smoke Detectors, Single & Multiple Station
UL 228 Door Closers/holders for Fire Protective Signaling Systems
UL 268 Smoke Detectors for Fire Protective Signaling Systems
UL 268A Smoke Detectors for Duct Applications
UL 346 Waterflow Indicators for Fire Protective Signaling Systems
UL 464 Audible Signaling Appliances
UL 521 Heat Detectors for Fire Protective Signaling Systems
UL 864 Standard for Control Units for Fire Protective Signaling Systems
UL 1481 Power Supplies for Fire Protective Signaling Systems
UL 1638 Visual Signaling Appliances
UL 1971 Visual Signaling Appliances

Underwriters Laboratories of Canada

7 Crouse Road
Scarborough, ON
Canada M1R 3A9

Canadian Electrical Code Part 1
ULC S527 Standard for Control Units for Fire Alarm Systems
ULC S524 Standard for the Installation of Fire Alarm Systems
ULC S536 Standard for the Inspection and Testing of Fire Alarm Systems
ULC S537 Standard for the Verification of Fire Alarm Systems
ULC ORD-C693-1994 Central Station Fire Protective Signaling System and Services

Content

Edwards Systems Technology
6411 Parkland Drive
Sarasota, FL 34243

2-CTM City Tie Module Installation Sheet (P/N 270496)
CDR-3 Bell Coder Installation Sheet (P/N 3100023)
DLD Dual Inline Dialer Installation Sheet (P/N 3100187)
PS6 Power Supply Card Installation Sheet (P/N 3100201)
QSA-1(X), QSA-2(X) Remote Annunciator Cabinet Installation Sheet (P/N 3100295)
QS-CPU(X) CPU/Display Unit Installation Sheet (P/N 3100276)
SL30, SL30-1 LED/Switch Card Installation Sheet (P/N 3100193)
SLIC Signature Intelligent Controller Card Installation Sheet (P/N 3100192)
RS485 (NT-A) Card and QS-232 UART Module Installation Sheet (P/N 3100191)
ZR8 Relay Card Installation Sheet (P/N 3100190)
SIGA-APS Auxiliary Power Supply Installation Sheet (P/N 387342)
Signature Series Intelligent Smoke and Heat Detectors Applications Bulletin (P/N 270145)
Signature Series Component Installation Manual (P/N 270497)
EST Strobe Applications Guide (P/N 85000-0049)
QuickStart Online Help Utility (P/N 7350047)
QuickStart ULI and ULC Compatibility Lists (P/N 3100335)
Network Hardware Technical Reference (P/N 250100)

Document history

Date	Revision	Description of changes
24JUN01	1.0	Original release.
12JUL01	2.0	Corrections and additions on pp 2.20, 3.9, 4.4, 4.8, 4.17, A.3.

Summary

This chapter provides a detailed description of the fire alarm control panel and its operation.

Content

- System overview • 1.2
- Component descriptions • 1.3
- Circuit descriptions • 1.4
- Controls and indicators • 1.7
- Controls and indicators behind the flip-down cover • 1.8
- Controls and indicators on the zone annunciator card • 1.9
- Interpretation of screen displays • 1.10

System overview

System hardware capabilities

Hardware capabilities vary depending on cabinet size and option card configuration, but generally:

- Up to four Class A or Class B Signature signaling line circuits that support up to 250 single-address Signature devices each
- Two Class A or Class B notification appliance circuits
- One 30-zone display
- Eight dry-contact relays
- 4.5 amps of 24 Vdc power for external notification appliances
- Battery charger capable of charging batteries rated up to 40 Ah. Maximum battery size for ULC applications is 30 Ah
- Up to eight, fully-supervised, mirrored or customized remote annunciators

Minimum system requirements

A Local Protected Premises Fire Alarm System requires only the FACP (CPU, PS6, and enclosure) with at least one SLIC programmed with at least one audible output circuit and one alarm input circuit.

In addition to the hardware requirements of a Local system:

- Add a 2-CTM City Tie Module for an Auxiliary Fire Alarm System
- Add a DLD Dual Line Dialer Card or RPM Reverse Polarity Module for a Remote Supervising Station Fire Alarm System
- Add a DLD Dual Line Dialer Card or RPM Reverse Polarity Module for a Central Station Fire Alarm System
- Add a SIGA-REL and SIGA-APS for Releasing Device Service

Normal operating mode description

The panel operates in normal mode in the absence of any alarm, supervisory, trouble, and monitor events. In normal mode, the control panel monitors the system for

any events.

Off-normal operating mode description

The panel operates in off-normal mode any time there is an event introduced into the system. When this happens, the CPU:

- Changes the contact positions on the appropriate common relays
- Activates all common alarm outputs (alarm events only)
- Turns on the panel buzzer
- Executes the appropriate programmed output response for the input that signaled the event
- Sends a record of the event to the appropriate display queue and out the serial port

If there is no operator in attendance, the panel displays the content of the highest priority display queue containing a record.

If there is an operator in attendance, the panel displays the content of the current display queue regardless of any new events introduced into the system.

Failsafe operating mode description

The panel operates in failsafe mode when the CPU loses the ability to communicate with the PS6 and JP1 on the PS6 is in the ON position. When this happens, the power supply:

- Closes the common trouble relay contacts
- Instructs the dialer to send the default trouble message
- Monitors the system for any alarm events

If an alarm event occurs, the power supply:

- Changes the contact positions on the common alarm relay
- Turns on all conventional common alarm outputs. Signature common alarm outputs are not affected.
- Instructs the dialer to send the default alarm message

Component descriptions

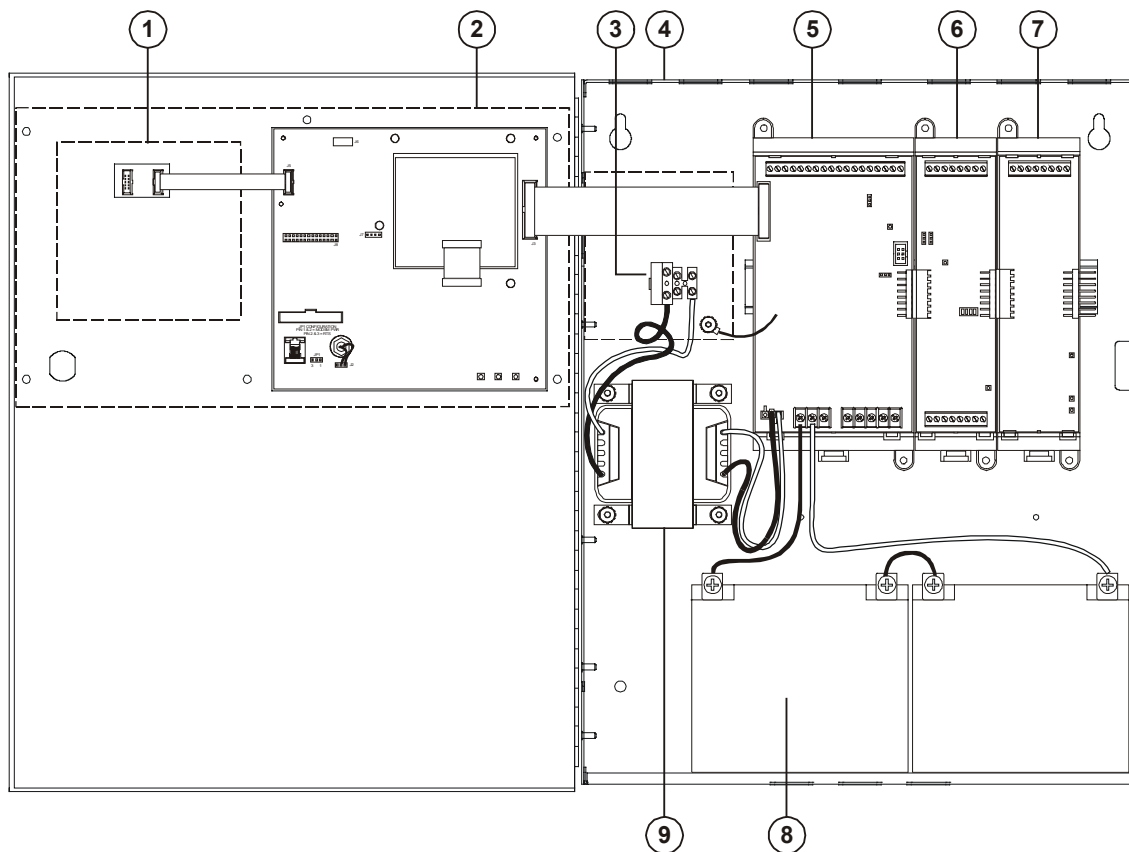

- 1. SL30 LED/Switch Card:** Provides thirty circuits for point or zone annunciation. Each circuit has two LEDs for annunciating alarm, supervisory, and trouble signals, and a button numbered from 1 to 30.
- 2. CPU/Display:** Provides operator access to system messages, status information, and programming menus, and executes system responses based on the panel programming.
- 3. AC wiring block and fuse holder:** Provides connections for mains ac (primary power) and 5A fuse.
- 4. Cabinet enclosure:** Houses the panel electronics and standby batteries.
- 5. PS6 Power Supply Card:** Provides primary dc power for the panel electronics and auxiliary power for external circuits. The PS6 also provides common alarm, supervisory and trouble relays.

- 6. SLIC Signature Loop Intelligent Controller Card:** Provides one Class A or Class B signaling line circuit (loop) for connecting Signature series detectors and modules. The SLIC also provides two Class A or Class B notification appliance circuits (NACs) for connecting polarized 24 Vdc notification appliances (horns, strobes).
- 7. DLD Dual Line Dialer Card:** Provides two telephone line connections for sending system messages to a compatible Digital Alarm Communicator Receiver.
- 8. Standby batteries:** Provides dc power to the panel electronics in the absence of ac power.
- 9. Transformer:** Converts 120 Vac or 240 Vac supply into 24 Vdc for the panel electronics.

Circuit descriptions

PS6 Power Supply Card

1. Relay 1 (Common Alarm)

Style: Form C
 Contact rating: 1 A @ 20.4 – 26.4 Vdc (0.6 PF)
 Wire size: 18 to 12 AWG (0.75 to 2.5 mm²)
 Nonsupervised and power-limited only when connected to a power-limited source

2. Relay 2 (Common Supervisory)

Style: Normally-open
 Contact rating: 1 A @ 20.4 – 26.4 Vdc (0.6 PF)
 Wire size: 18 to 12 AWG (0.75 to 2.5 mm²)
 Nonsupervised and power-limited only when connected to a power-limited source

3. Relay 3 (Common Trouble)

Style: Normally-open, held closed
 Contact rating: 1 A @ 20.4 – 26.4 Vdc (0.6 PF)
 Wire size: 18 to 12 AWG (0.75 to 2.5 mm²)
 Nonsupervised and power-limited only when connected to a power-limited source

4. Relay 4 (Programmable)

Style: Normally-open
 Contact rating: 1 A @ 20.4 – 26.4 Vdc (0.6 PF)
 Wire size: 18 to 12 AWG (0.75 to 2.5 mm²)
 Nonsupervised and power-limited only when connected to a power-limited source

5. Smoke/Accessory Power

Output: Continuous or interruptible via jumper selection
 Voltage: 24 Vdc, regulated
 Current: 250 mA
 Wire size: 18 to 12 AWG (0.75 to 2.5 mm²)
 Supervised and power-limited

6. RS485

Wire size: 18 to 12 AWG (0.75 to 2.5 mm²)
 Wire type: Twisted pair, six twists per foot minimum
 Circuit capacitance: 0.4 μF
 Circuit resistance: 100 Ω
 Supervised and power-limited

7. RS232

Wire size: 18 to 12 AWG (0.75 to 2.5 mm²)
 Nonsupervised and power-limited
 Wire length: 20 ft maximum

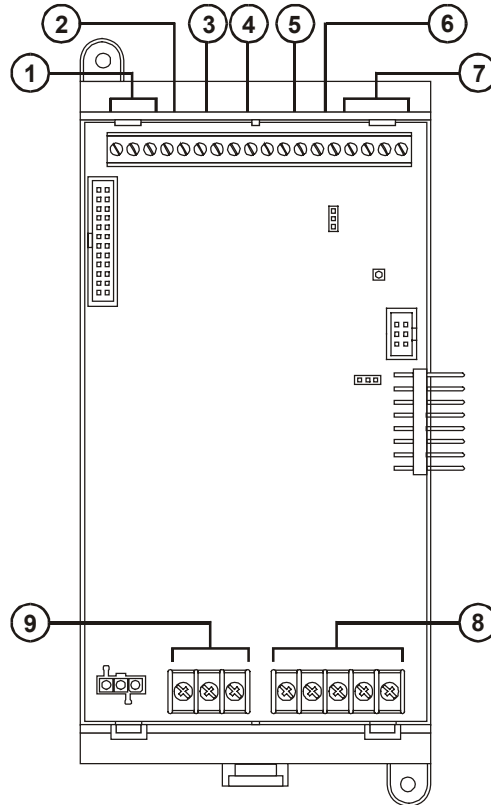

8. AUX Power #1, #2, and #3

Voltage: 17.5 – 26.4 Vdc FWR (full wave rectified)
 Current: 1.5 A each
 Wire size: 18 to 12 AWG (0.75 to 2.5 mm²)
 Power-limited and supervised for short circuit conditions only

9. Battery Circuit

Charge current: 2 A
 Charge capacity: 40 Ah (UL), 30 Ah (ULC)
 Supervised and nonpower-limited

SLIC Signature Loop Intelligent Controller Card circuits

1. NAC #1

Configuration: Class B or Class A
Output voltage: 24 Vdc, nominal
Output current: 2.0 A @ 24 Vdc
Wire size: 18 to 12 AWG (0.75 to 2.5 mm²)
End of line resistor: 10 k Ω , 1/2W
Supervised and power-limited

2. NAC #2

Configuration: Class B or Class A
Output voltage: 24 Vdc, nominal
Output current: 1.0 A @ 24 Vdc
Wire size: 18 to 12 AWG (0.75 to 2.5 mm²)
End of line resistor: 10 k Ω , 1/2W
Supervised and power-limited

3. Signature Loop

Configuration: Class B (Style 4) or Class A (Style 6)
Capacity: 125 Signature detectors, 125 Signature single-address modules
Wire size: 18 to 12 AWG (0.75 to 2.5 mm²)
Circuit resistance: 65 Ω
Circuit capacitance: 0.3 μ F
Supervised and power-limited

4. NAC Riser In/Out

Voltage: 24 Vdc, nominal
Wire size: 18 to 12 AWG (0.75 to 2.5 mm²)

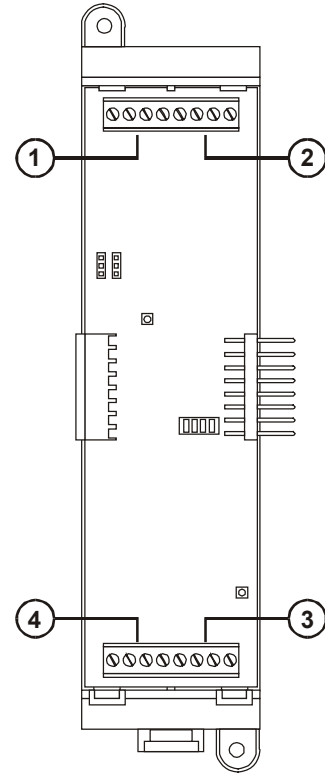

ZR8 Relay Card circuits

1. Dry-contact relays R1 – R4

Outputs: Normally-open or normally-closed contacts via jumper selection
Contact rating: 24 Vdc @ 1.0 A
Wire size: 18 to 12 AWG (0.75 to 2.5 mm²)
Nonsupervised, and power-limited only when connected to a power-limited source

2. Dry-contact relays R5 – R8

Outputs: Normally-open or normally-closed contacts via jumper selection
Contact rating: 24 Vdc @ 1.0 A
Wire size: 18 to 12 AWG (0.75 to 2.5 mm²)
Nonsupervised, and power-limited only when connected to a power-limited source

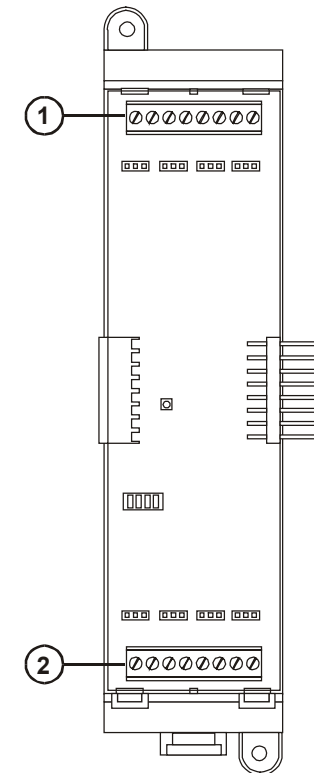

Product description

DLD Dual Line Dialer Card circuits

- 1. **Line #1**
Supervised and nonpower-limited
- 2. **Line #2**
Supervised and nonpower-limited

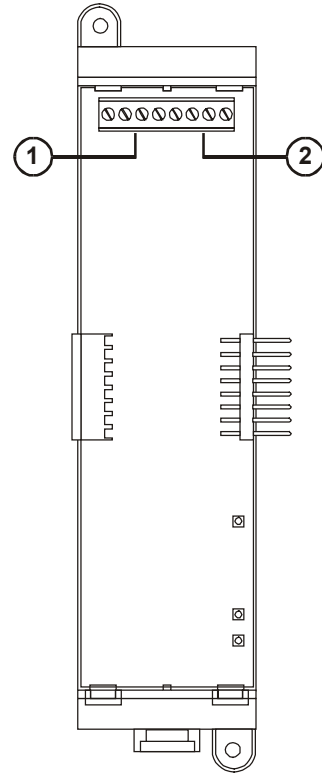

RS485 (NT-A) Class A Card circuits



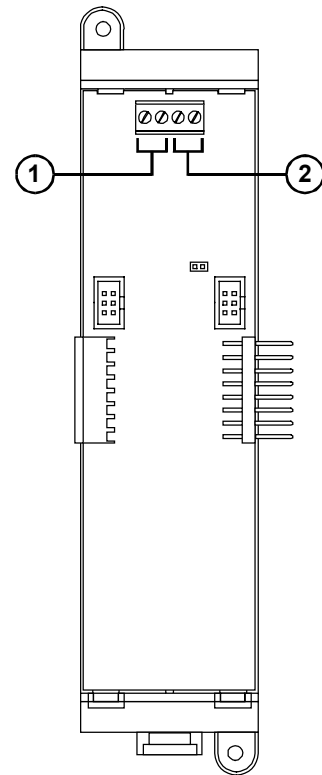

- 1. **Secondary RS485 channel**
Wire size: 18 to 12 AWG (0.75 to 2.5 mm²)
Supervised and power-limited
- 2. **Primary RS485 channel**
Wire size: 18 to 12 AWG (0.75 to 2.5 mm²)
Supervised and power-limited

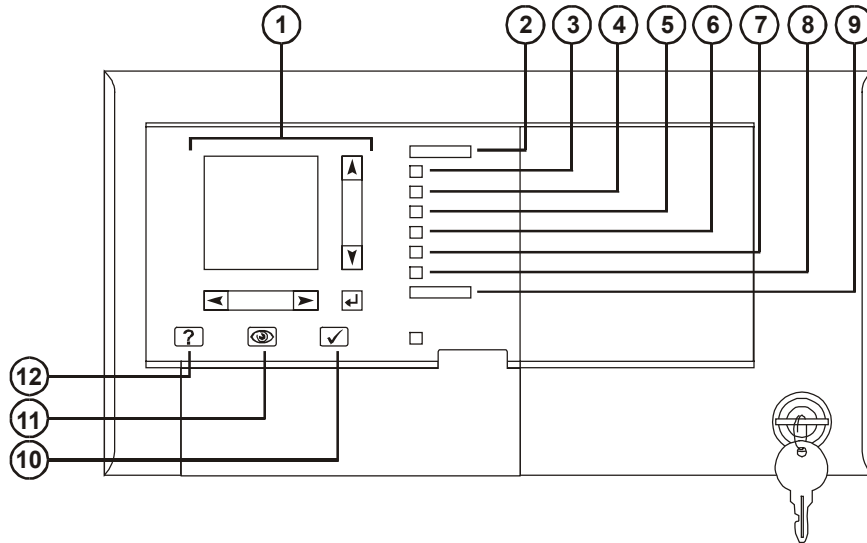

Controls and indicators



1. Text display and controls: Displays system messages, status information, programming menus.

-  Moves the cursor up one line at a time or to the previous record in the display queue
-  Moves the cursor down one line at a time or to the next record in the display queue
-  Moves the cursor right one character at a time or to the next display queue
-  Moves the cursor left one character at a time or to the previous display queue
-  Enters operator input and selects menu items

2. Alarm LED: Indicates the panel posted an alarm event record into the corresponding display queue.

3. Supervisory LED: Indicates the panel posted a supervisory event record into the corresponding display queue.

4. Disable/Test LED: Indicates part of the system is disabled or is currently under test. Disabled components also signal a system trouble.

5. Monitor LED: Indicates the panel posted a monitor event record into the corresponding display queue.

6. Trouble LED: Indicates the panel posted a trouble event record into the corresponding display queue.

7. Ground Fault LED: Indicates a ground fault in the system wiring. Ground faults also signal a system trouble.

8. CPU Fail LED: Indicates an unexpected reboot or failure with the microprocessor. CPU failures also signal a system trouble.

9. Power LED: Indicates the panel has ac power.

10. Panel Silence/Acknowledge button/LED: Turns off the panel buzzer and acknowledges all events. The Panel Silenced LED indicates that all off normal events have been acknowledged and the internal buzzer is off.

11. Status button: Displays the Status menu from which you can identify active or disabled points in the system.

12. Help button: Provides additional information for the event record selected on the display.

Controls and indicators behind the flip-down cover

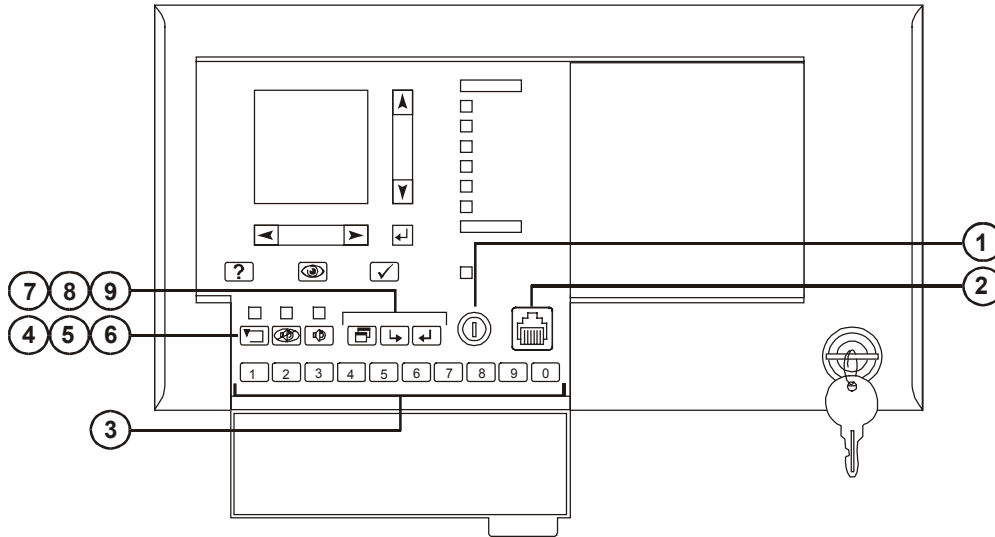

1. Enable Controls key switch: Gives priority access to control functions reserved for operators with Level 2 access.

2. Barcode scanner jack: Input point for optional barcode scanner.

3. Numeric keypad: Numbered buttons for entering data and selecting menu options.

4. Reset button: Restores devices or zones in alarm or trouble to their standby condition. The LED indicates when the panel is resetting.

5. Alarm Silence button: Turns active notification appliances off according to the panel programming. Pressing Alarm Silence a second time turns them back on. The LED indicates when the panel is in alarm and operating with notification appliances turned off.

6. Drill button: Turns notification appliances on according to the panel programming but does not place the panel in alarm. The LED indicates when the panel is in Drill mode.

7. Menu button: Displays the operator menus.

8. Delete button: Returns to the previous menu or back spaces the cursor.

9. Enter button: Press the Enter button to accept information from the operator or continue to the next item.

Controls and indicators on the zone annunciator card

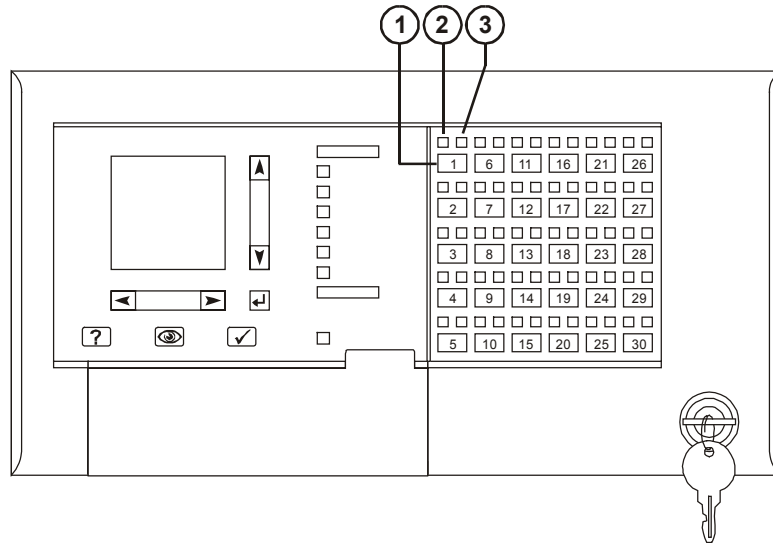

1. Zone display button: Displays an event record for each device in the corresponding zone that signaled an alarm.

2. Zone active LED: Indicates a device in the corresponding zone signaled an alarm condition.

3. Zone trouble LED: Indicates a device or wiring fault in the corresponding Zone.

Note: ULC requires that every fire panel have the capability to visually display system status by means of specific indicators for each zone. All status changes must clearly indicate that the information is an Alarm (ALM), Supervisory (SUP), Trouble (TBL), or Monitor (MON).

Interpretation of screen displays

```
HH:MM:SS   MM/DD

System
Normal

Project Name

Alarm History:
nnnn
```

This is what the panel display looks like when there are no event records posted in a display queue.

HH:MM:SS is the current time in hours, minutes, and seconds

MM/DD is the current month and date

nnnn is the number times the panel went into alarm since being placed into service

```
HH:MM:SS
Axxx Dxxx

▶ nnn event name
Custom message 1
Custom message 2

   nnn event name
Custom message 1
Custom message 2

ALM SUP TRBL MON
aaa sss  ttt mmm
```

This is what the panel display looks like when there are event records posted in a display queue.

HH:MM:SS is the current time in hours, minutes, and seconds

Axxx is the current number of active points

Dxxx is the current number of disabled points

These items comprise the event record:

nnn is the posting sequence number (001 = first, 002 = second, and so on)

event name is the event produced when the device changed states. Refer to Table 1-1.

P:pp C:cc D:ddd is the address of the device that signaled the event (P = panel number, C = card number, D = device number)

The event record may also include a custom message that typically indicates the location of the device, depending on the panel programming.

These items indicate the content of the display queues:

aaa is the number of alarm event records (highest priority)

sss is the number of supervisory event records

ttt is the number of trouble event records

mmm is the number of monitor event records (lowest priority)

Table 1-1: Event descriptions

Event name	Event type	Description
ALARM ACTIVE	Alarm	Smoke detector active
ALARM VERIFY	Monitor	Alarm active. Performing auto reset.
AND GROUP	Alarm	And group active
BAD PRSONATY	Trouble	SIGA personality mismatch
BAD TYPE	Trouble	SIGA type mismatch
COMM FAULT	Trouble	Communication failure
DEV COMPATIB	Trouble	SIGA compatibility fault
DIRTY HEAD	Trouble	Dirty smoke detector. No compensation remaining
DISAB SOUND	Trouble	Sounder is disabled (EN-54 only)
DISABLED	Trouble	Device is disabled
GROUND FAULT	Trouble	Ground fault
HEAT ALARM	Alarm	Heat detector active
INTERNAL TBL	Trouble	Internal system trouble
LCL MONITOR	Monitor	Common monitor
LCL TROUBLE	Trouble	Generic trouble.
MAINT ALERT	Monitor	Dirty smoke detector. Some compensation remaining
MATRIX GROUP	Alarm	Matrix group active
MONITOR	Monitor	Active non-latching input circuit.
OBJECT RUN	Monitor	Service group is enabled and governing all defined objects
PREALARM	Monitor	Possible fire condition exists.
PULL STATION	Alarm	Manual fire alarm box active
SERVICE GROUP	Trouble	Service group active
SUPERVISORY	Supervisory	A device used to monitor a component of the fire suppression system is active
SWITCH	Monitor	Operator presses switch on LED/Switch card
TAMPER	Supervisory	Sprinkler tamper active
TEST	Trouble	A member of a Service group under test is activated
TIME CONTROL	Monitor	Time control active
TROUBLE	Trouble	Common trouble
TROUBLE OPEN	Trouble	Open detected on a supervised output device's field wiring
TROUBLE SHORT	Trouble	Short detected on a supervised output device's field wiring
UNEXPECT DEV	Trouble	Signature device not defined in database
WATERFLOW	Alarm	Water flowing through the sprinkler system
ZONE ALARM	Alarm	Alarm zone active
ZONE MONITOR	Monitor	Monitor zone active
ZONE SUPER	Supervisory	Supervisory zone active

Product description

Summary

This chapter provides instructions for installing the fire alarm control panel.

Content

- Installation do's and don'ts • 2.2
- Installation checklist • 2.3
- Two ways to install the cabinet: Surface or semi-flush mount • 2.4
- How to assemble the panel • 2.5
- Wiring mains ac and earth ground • 2.6
- System jumper settings • 2.7
- System addressing • 2.9
- Terminal definitions • 2.12
- Connecting a PT-1S printer • 2.18
- Installing standby batteries • 2.19
- Connecting a service computer • 2.20

Installation do's and don'ts

- When installing cabinets...**
- DO** use fasteners that can support the full weight of the cabinet and standby batteries. Tighten firmly to avoid vibrations.
 - DO NOT** drill inside the cabinet with circuit cards installed. Remove all metal filings before installing the circuit cards.
 - DO NOT** recess the cabinet into the wall deeper than 2–11/16 inches (68.2 mm) from the finished wall surface to allow room for the trim kit.
- When installing circuit boards...**
- DO** ground yourself with an approved static-protective wrist strap when handling circuit boards.
 - DO** keep circuit boards in their protective antistatic packaging. Remove only for inspection or installation.
 - DO NOT** touch component leads and connector pins when handling circuit boards.
 - DO** disconnect ac power and batteries before installing or removing circuit boards. Installing or removing circuit boards while the control panel is energized may damage the equipment.
- When installing circuit wiring...**
- DO** use appropriately sized wire for the application. Incorrectly-sized wires degrade circuit performance.
 - DO** make sure there are no wire-to-ground shorts or wire-to-wire shorts before connecting field wires to the panel.
 - DO NOT** over tighten screw terminals. Over tightening may strip screw terminal threads and cause loose connections.
- When installing Signature loops...**
- DO NOT** install more than fifteen SIGA–UMs or MABs configured for two-wire smoke detectors on a loop.
 - DO NOT** install more than seven SIGA–UMs or MABs configured for two-wire smoke detectors on loops with isolator devices.
 - DO NOT** install more than ten SIGA–RELS on a loop. You must use the QuickStart configuration utility to program a SIGA–REL. Refer to the technical manual supplied with the SIGA–REL and appendix C of this manual for programming information.
- When installing standby batteries...**
- DO NOT** install standby batteries until after you completely install and test the system.

Installation checklist

- | | |
|---|---|
| <input type="checkbox"/> Prepare the site | <p>Make sure the installation location is free from construction dust and debris, and immune to extreme temperature ranges and humidity.</p> <p>Allow enough floor and wall space so the panel can be installed and serviced without obstructions.</p> <p>Pull and tag all field wiring. See Appendix A for wire length calculations.</p> |
| <input type="checkbox"/> Unpack the equipment | <p>Open the shipping container and carefully unpack the equipment. Check for any visible signs of damage. If there is any damage, return the equipment to the place of purchase.</p> <p>Keep the shipping container and packing material until after completely installing and testing the equipment. Use the shipping container to return the equipment to the manufacturer.</p> <p>Verify the shipping container contains the correct parts. If any parts are missing or damaged, return the equipment to the manufacturer.</p> |
| <input type="checkbox"/> Install the cabinet | |
| <input type="checkbox"/> Assemble the panel | |
| <input type="checkbox"/> Wire mains ac and earth ground | <p>Bring the primary power conductors into the left side (nonpower-limited area) of the cabinet and wire to the ac terminal block.</p> |
| <hr/> <p>WARNING: Make sure that the circuit breaker providing ac power is switched off before connecting wires to the terminal block.</p> <hr/> | |
| <input type="checkbox"/> Connect the field wiring | <p>Bring the field wiring into the power-limited area of the cabinet. Verify there are no open or shorts then connect the wires to their respective terminals.</p> |
| <input type="checkbox"/> Use the AutoLearn and AutoLoop utilities to configure the system | <p>Refer to chapter 4.</p> |
| <input type="checkbox"/> Customize the system configuration | <p>Refer to chapter 4.</p> |
| <input type="checkbox"/> Install the standby batteries | <p>Do not connect standby batteries to the panel until after completely testing the panel.</p> |
| <input type="checkbox"/> Perform system acceptance tests | |

Two ways to install the cabinet: Surface or semi-flush mount

Surface mount instructions

1. Position the cabinet on the finished wall surface.
2. Fasten the cabinet to the wall surface where indicated. Tighten firmly.

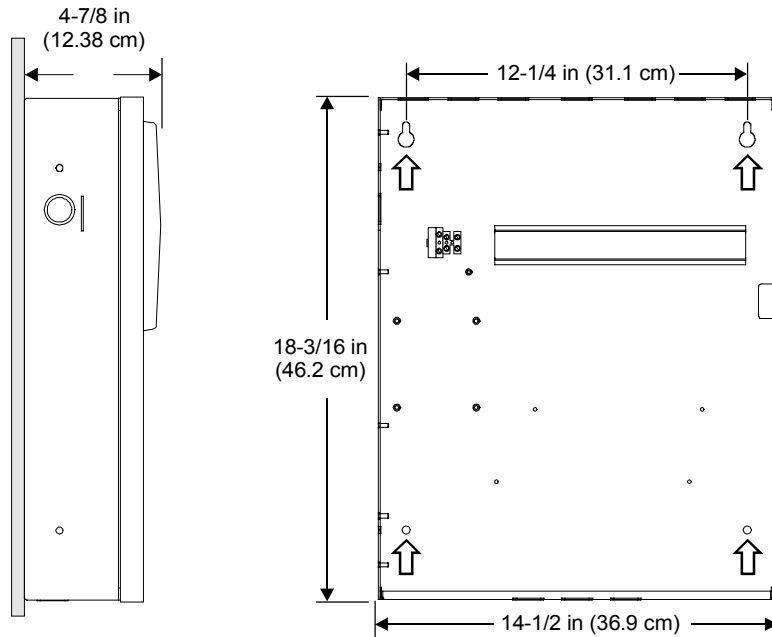

Semi-flush mount instructions

1. Frame the interior wall as required to support the full weight of the cabinet and standby batteries.
2. Fasten the cabinet to the framing studs where indicated. Tighten firmly.

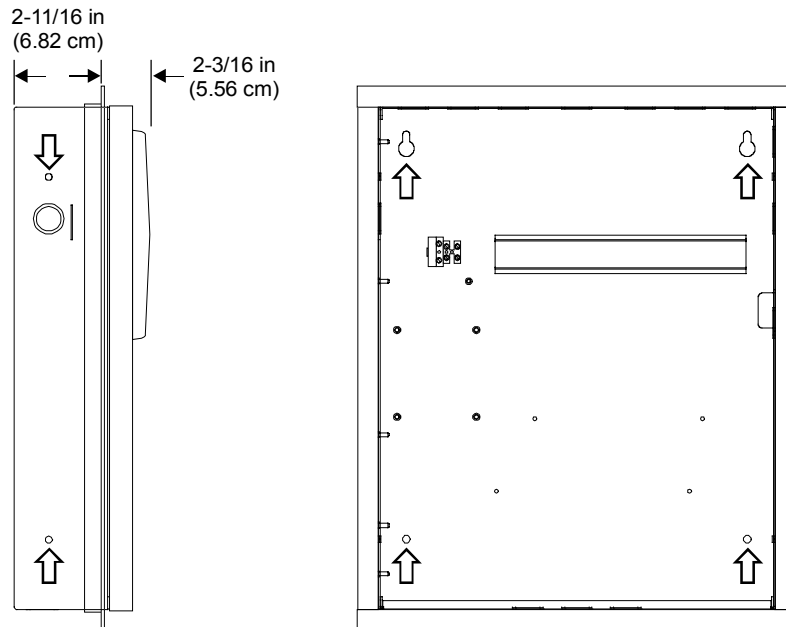

How to assemble the panel

Circuit card instructions

1. Lock the PS6 onto the DIN rail and configure jumpers.
2. Attach the ground wire to the cabinet. Tighten the lock nut firmly to ensure a good mechanical and electrical connection.
3. Plug the transformer into the PS6.
4. Install remaining option cards according to their respective installation sheets.

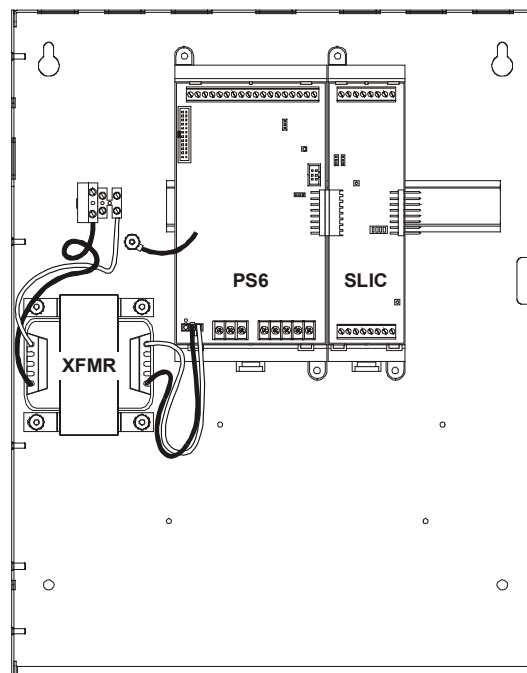

Door mounting instructions

1. Bolt the door to the cabinet back box.
2. Attach one end of the ground strap to the door and the other to the back box.
3. Screw the CPU/Display unit to the cabinet door.
4. Plug one end of the ribbon cable into the CPU/Display and the other end into the PS6.
5. Screw the key switch ground wire and the CPU cover to the cabinet door.

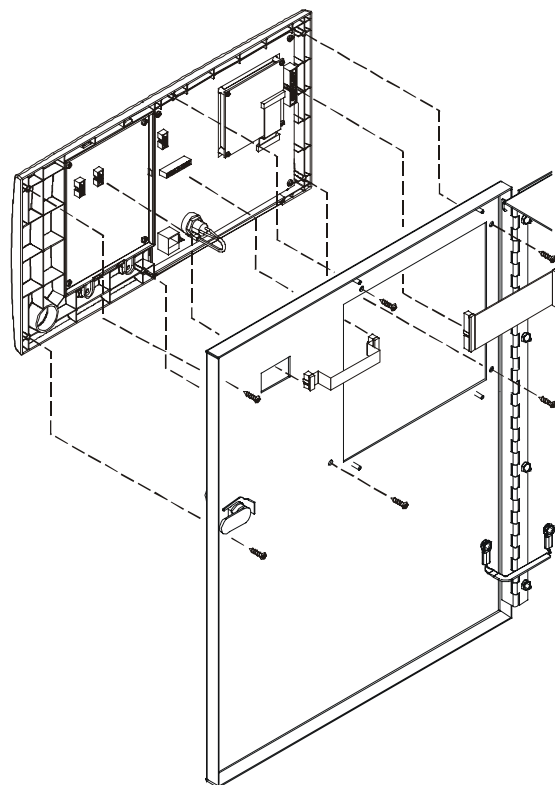

Wiring mains ac and earth ground

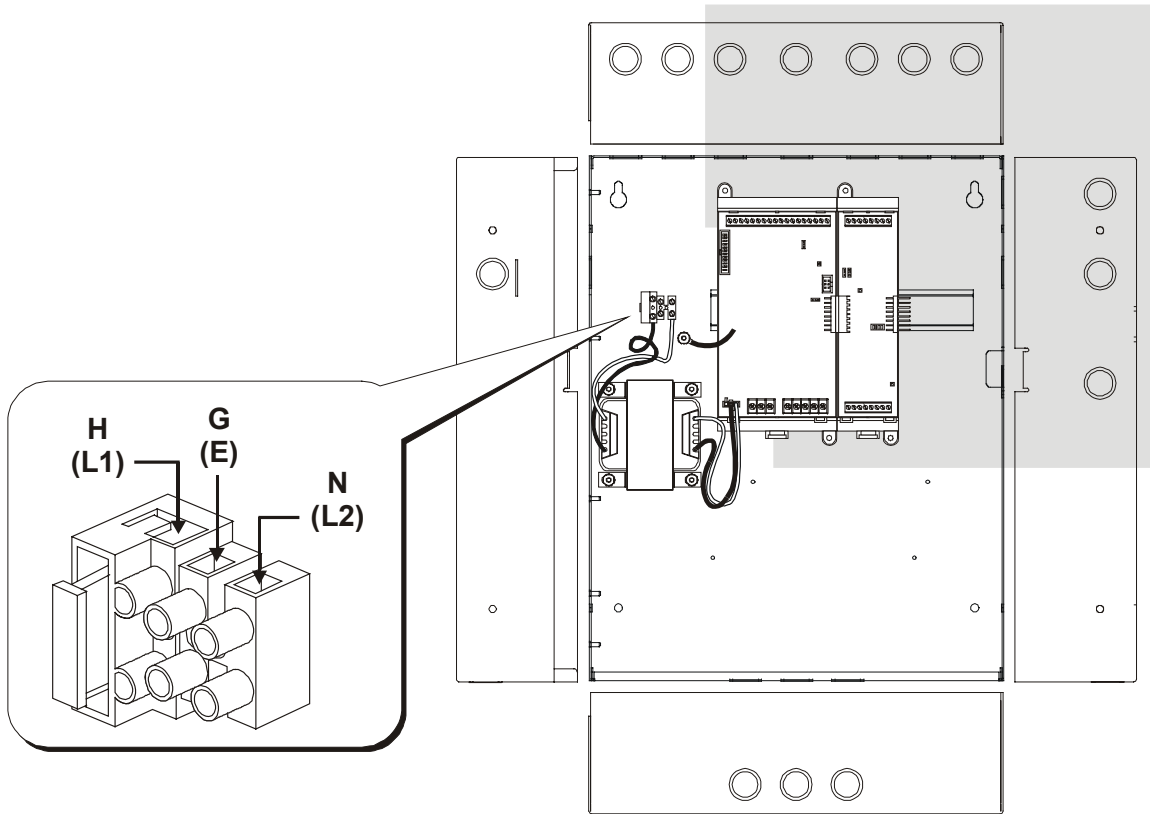

CAUTION: The middle connection on the ac terminal block makes a mechanical connection to chassis (earth) ground. Do not allow the ac hot and neutral conductors to make contact with the middle connector on the ac terminal block.

Wiring instructions

1. Bring the mains ac conductors into the cabinet through the 3/4–1/2 inch combination knock-outs on the left side or upper left corner of the cabinet.
2. Wire the hot (H, L1), neutral (N, L2), and ground (G, E) conductors to the ac terminal block as shown.
3. Insert tabbed end of terminal block cover (deadfront) into the slot provided on the side of the cabinet.

Notes

Keep power-limited wires in the shaded area and nonpower-limited wires in the nonshaded area.

Maintain a 1/4-inch separation between the mains ac and battery wires (power-limited) and all other nonpower-limited wiring at all times.

System jumper settings

PS6 Power Supply Card jumpers

JP2 configures the Smoke/Accessory power output for constant or resettable 24 Vdc.

- Set JP2 to ACC PWR to provide constant 24 Vdc for external equipment.
- Set JP2 to SMK PWR to provide resettable 24 Vdc for four-wire smoke detectors

JP1 configures the panel for failsafe operation. Failsafe allows the system to generate output responses even when the CPU loses communication with the power supply card.

- Set JP1 to ON to turn failsafe mode on
- Set JP1 to OFF to turn failsafe mode off

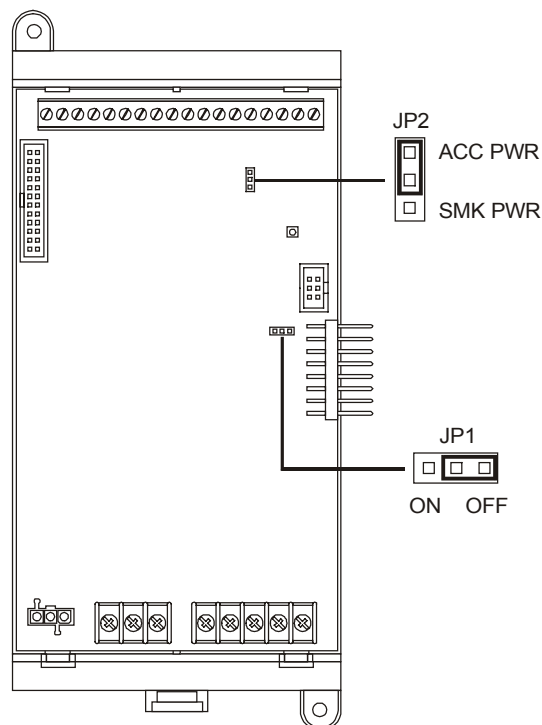

SLIC Signature Loop Intelligent Controller Card jumpers

JP1 and JP2 selects the signal that the SLIC uses for the notification appliances connected to NAC1.

Note: NAC 2 always uses the external signal connected to TB2-3 and TB2-4.

- Set JP1 and JP2 to INT to use the 24 Vdc that comes from the PS6 over the bus connection.
- Set JP1 and JP2 to EXT to use the 24 Vdc that comes from an external source connected to TB2-3 and TB2-4.

CAUTION: Do not set JP1 and JP2 to EXT if strobes are connected to NAC 1 and a coded signal is connected to TB2-3 and TB2-4.

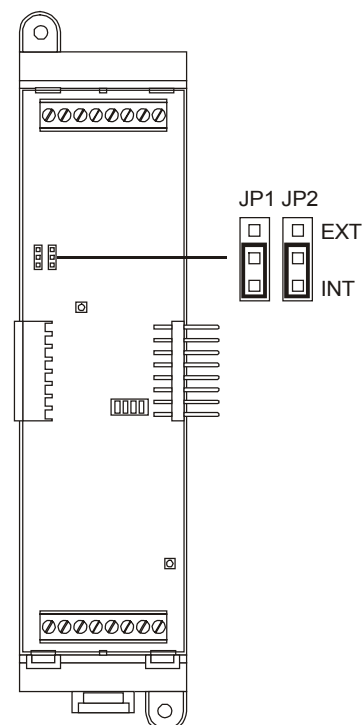

ZR8 Relay Card jumpers

JP1 – JP8 configure which relay contacts are present on the terminal connections for R1 – R8, respectively.

The normal operating state of the relay (on or off when the panel is normal) determines whether the terminal connections are normally-open or normally-closed.

The figure to the right shows the relay contact positions when the relay is turned off.

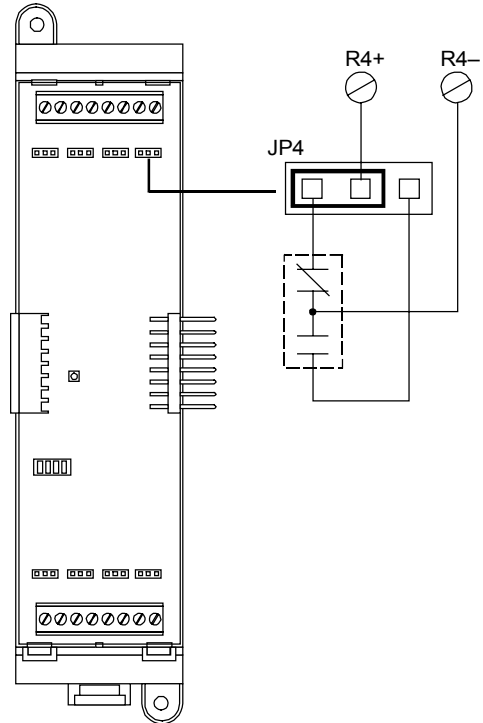

RS485 (NT-A) Card jumpers

JP1 configures ground fault supervision for Class A remote annunciators.

- Set a shorting plug across JP1-1 and JP1-2 when the PS6 powers the remote annunciator and provides ground fault supervision
- Set a shorting plug across JP1-2 and JP1-3 when an external supply powers the remote annunciator and provides ground fault supervision

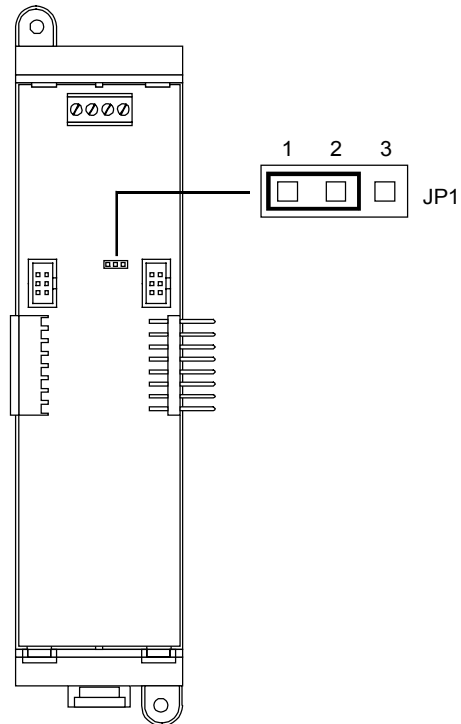

System addressing

Card addresses

Each option card installed in the panel is assigned a unique card address. Only the SLIC, ZB16–8, ZA8–2, and ZR8 have card addresses that you can set. The CPU, DLD and PS6 card addresses are fixed.

00: Reserved for the CPU

01–07: Used for the SLIC or ZR8

08–13: Used for the ZR8

14: Reserved for the DLD

15: Reserved for the PS6

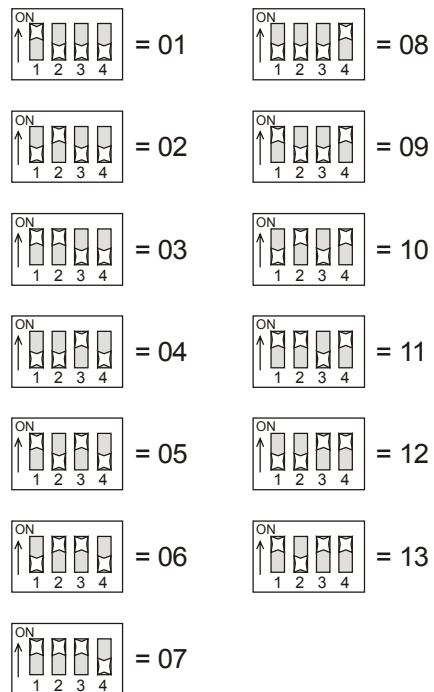

Tip: When you install the option cards, set the card addresses in consecutive order as you move away from the power supply starting at address 01.

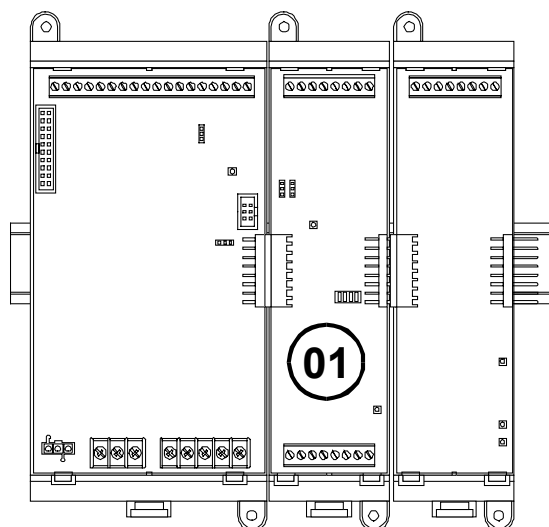

Installation

SLIC Signature Loop Intelligent Controller Card device addresses

The device address format is PPCCDDD, where:

PP is the panel number (01)

CC is the card number (any number between 1 and 7 depending on the setting of SW1)

DDD is the device or circuit number, where:

- 001–125 are Signature automatic detectors and SIGA–IM isolator modules
- 126–250 are Signature modules
- 270 is the NAC 1 output circuit
- 271 is the NAC 2 output circuit

Note: Some Signature modules use two or more device addresses.

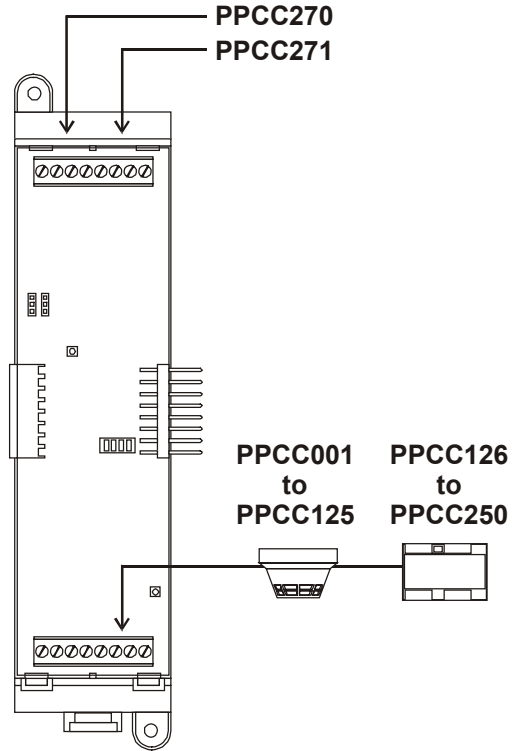

ZR8 Relay Card device addresses

The device address format is PPCCDDD, where:

PP is the panel number (01)

CC is the card number (any number between 1 and 13 depending on the setting of SW1)

DDD is the device number, where 001 – 008 are relays 1 – 8, respectively

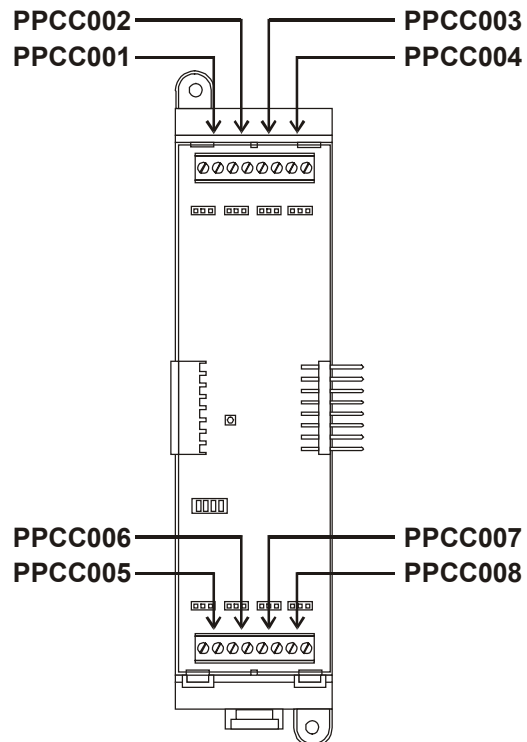

SL30 LED/Switch Card device addresses

The device address format is GGSS for switches and GGSSL for LEDs, where:

GG is the group number (01 for SL30, 02 for SL30-1)

SS is the switch number

L is the LED number, where:

- 1 is the red Alarm LED
- 2 is the yellow Active LED
- 3 is the yellow Trouble LED

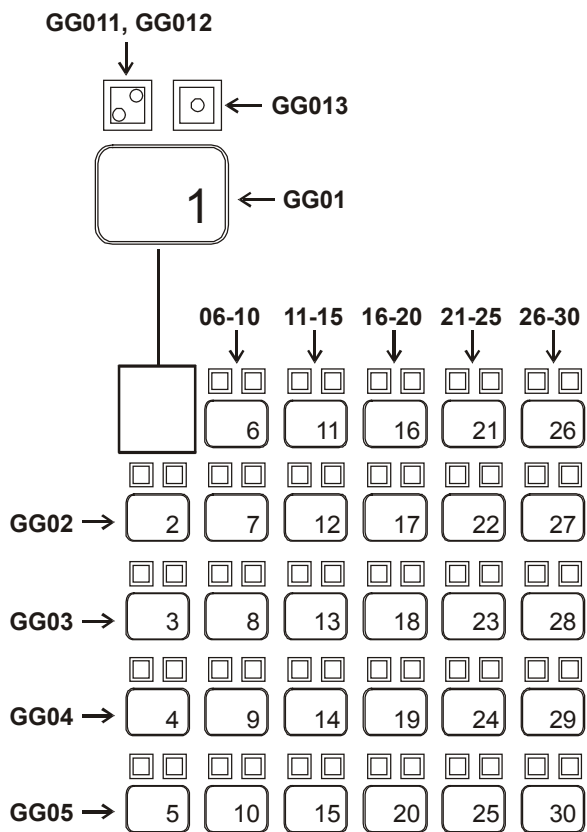

Terminal definitions

Table 2-1: PS6 Power Supply card terminal definitions

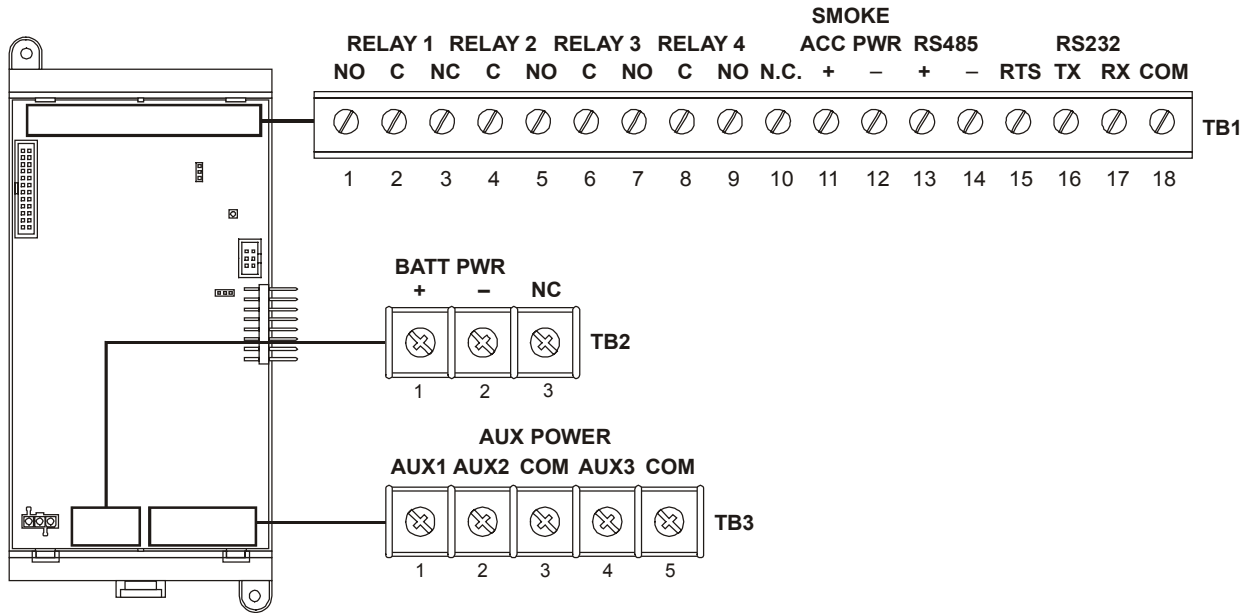

Terminal No.	Name	Description
TB1-1, -2	Relay 1 NO, C	Normally-open relay contacts that close automatically when the panel processes an alarm event. The contacts remain closed until all active alarm points restore and the panel resets.
TB1-2, -3	Relay 1 C, NC	Normally-closed relay contacts that open automatically when the panel processes an alarm event. The contacts remain open until all active alarm points restore and the panel resets.
TB1-4, -5	Relay 2 C, NO	Normally-open relay contacts that close automatically when the panel processes a supervisory event. The contacts remain closed until the active supervisory point restores.
TB1-6, -7	Relay 3 C, NO	Normally-open relay contacts that close automatically when the panel energizes. The contacts open when the panel processes a trouble event or when the panel loses power and remain open until the trouble condition restores.
TB1-8, -9	Relay 4 C, NO	Normally-open relay contacts that close depending on how the user programs the panel.
TB1-10	N.C.	Not used
TB1-11, -12	SMK/ACC PWR +, -	Provides regulated 24 Vdc for four-wire smoke detectors or accessory devices depending on jumper setting.
TB1-13, -14	RS485 +, -	Connects to the Channel 1 input on a remote annunciator

Terminal No.	Name	Description
TB1-15	RS232 RTS	Not used
TB1-16	RS232 RX	Connects to the data transmit (TX) terminal on a peripheral device.
TB1-17	RS232 TX	Connects to the receive data (RX) terminal on a peripheral device.
TB1-18	RS232 COM	Connects to the common ground (COM) terminal on a peripheral device.
TB2-1	BATT PWR +	Connects to the positive terminal on the standby battery.
TB2-2	BATT PWR -	Connects to the negative terminal on the standby battery.
TB2-3	NC	Not used.
TB3-1	AUX1	Provides 24 Vdc, FWR power to auxiliary devices. Note: AUX1, AUX2, and AUX3 can not be used to power remote annunciators
TB3-2	AUX2	Provides 24 Vdc, FWR power to auxiliary devices.
TB3-3	COM	Negative reference for AUX1 and AUX2 outputs.
TB3-4	AUX3	Provides 24 Vdc, FWR power to auxiliary devices.
TB3-5	COM	Negative reference for AUX3 output.

Table 2-2: SLIC Signature Loop Intelligent Controller card

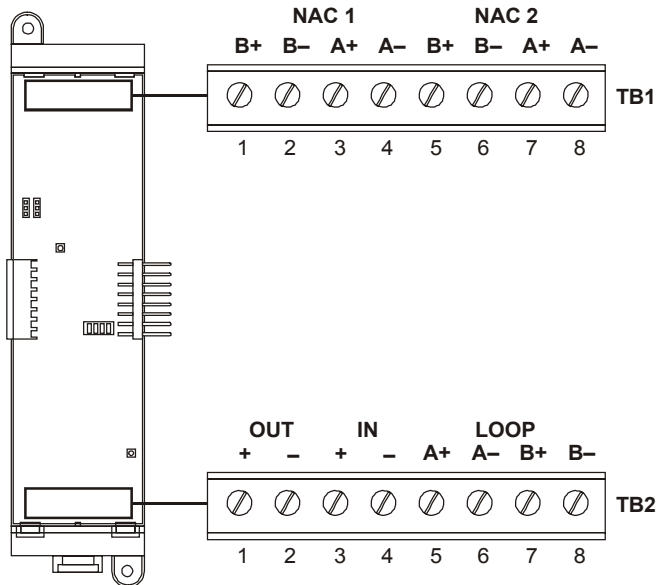

Terminal No.	Name	Description
TB-1, -2	NAC 1 B+, B-	Connects to the IN +/- terminals of the first device on the NAC circuit. Polarity markings (+/-) indicate output signal polarity with the circuit turned off. Polarity reverses with the circuit turned on.
TB-3, -4	NAC 1 A+, A-	Connects to the OUT +/- terminals of the last device on the NAC circuit. Class A configuration only.
TB-5, -6	NAC 2 B+, B-	Connects to the IN +/- terminals of the first device on the NAC circuit. Polarity markings (+/-) indicate output signal polarity with the circuit turned off. Polarity reverses with the circuit turned on.
TB-7, -8	NAC 2 A+, A-	Connects to the OUT +/- terminals of the last device on the NAC circuit. Class A configuration only.
TB2-1, -2	OUT+, OUT-	Connects to the next device on the same 24VDC riser used to provide 24 Vdc to NAC 1 and NAC 2.
TB2-3, -4	IN+, IN-	Connects to the signal source used to provide 24 Vdc to NAC 1 and NAC 2.
TB2-5, -6	LOOP A+, A-	Connects to the DATA OUT +/- terminals of last device on the Signature signaling line circuit. Class A configuration only.
TB2-7, -8	LOOP B+, B-	Connects to the DATA IN +/- terminals of the first device on the Signature signaling line circuit.

Table 2-3: ZR8 Relay card terminal definitions

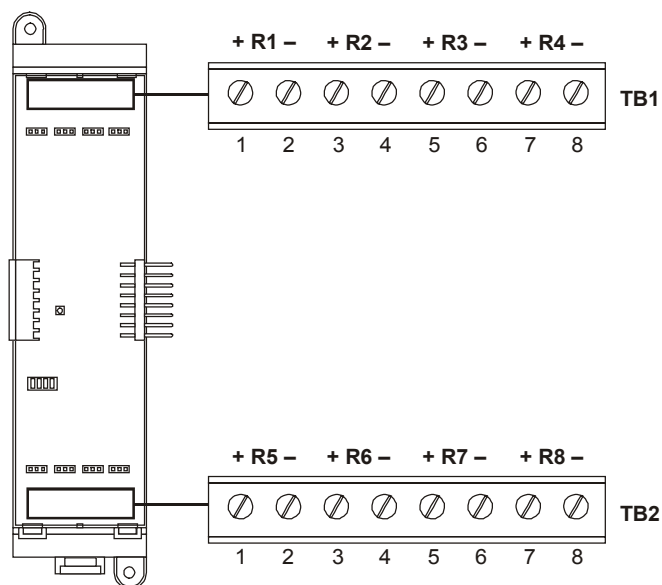

Terminal No.	Name	Description
TB1-1, -2	R1+, R1-	Terminal connections for relay 1.
TB1-3, -4	R2+, R2-	Terminal connections for relay 2.
TB1-5, -6	R3+, R3-	Terminal connections for relay 3.
TB1-7, -8	R4+, R4-	Terminal connections for relay 4.
TB2-1, -2	R5+, R5-	Terminal connections for relay 5.
TB2-3, -4	R6+, R6-	Terminal connections for relay 6.
TB2-5, -6	R7+, R7-	Terminal connections for relay 7.
TB2-7, -8	R8+, R8-	Terminal connections for relay 8.

Table 2-4: RS485 (NT-A) Class A card terminal definitions

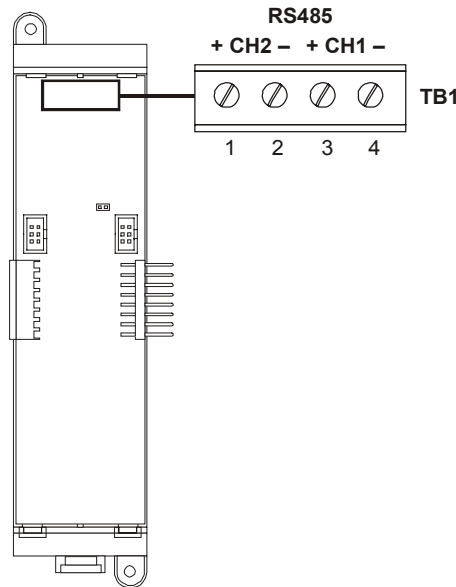

Terminal No.	Name	Description
TB1-1, -2	CH2+, CH2-	Connects to CH2+/- on the first remote annunciator on the Class A RS485 riser.
TB1-3, -4	CH1+, CH1-	Connects to CH1+/- on the first remote annunciator on the Class A RS485 riser.

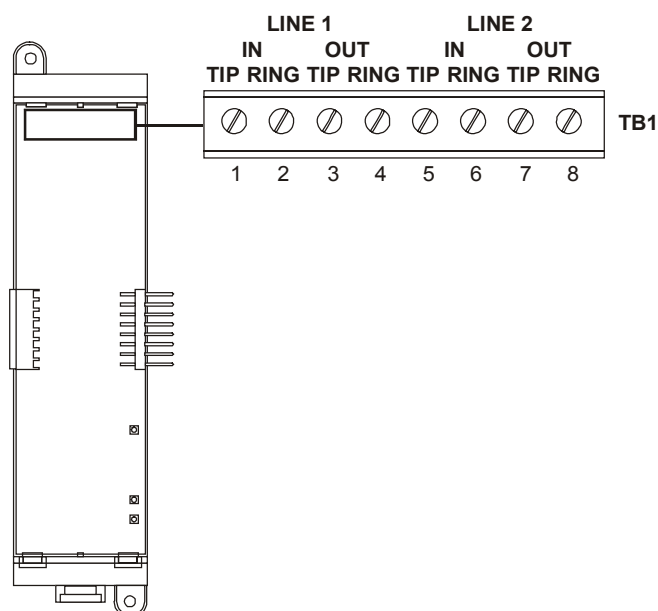
Table 2-5: DLD Dual Line Dialer card terminal definitions

Terminal No.	Name	Description
TB1-1	LINE 1 TIP IN	Connects to the Tip In connector on the telco side of an RJ31X block via an RJ-12 modular cable.
TB1-2	LINE 1 RING IN	Connects to the Ring In connector on the telco side of an RJ31X block via an RJ-12 modular cable.
TB1-3	LINE 1 TIP OUT	Connects to the Tip Out connector on the protected premises side of an RJ31X block via an RJ-12 modular cable.
TB1-4	LINE 1 RING OUT	Connects to the Ring Out connector on the protected premises side of an RJ31X block via an RJ-12 modular cable.
TB1-5	LINE 2 TIP IN	Connects to the Tip In connector on the telco side of an RJ31X block via an RJ-12 modular cable.
TB1-6	LINE 2 RING IN	Connects to the Ring In connector on the telco side of an RJ31X block via an RJ-12 modular cable.
TB1-7	LINE 2 TIP OUT	Connects to the Tip Out connector on the protected premises side of an RJ31X block via an RJ-12 modular cable.
TB1-8	LINE 2 RING OUT	Connects to the Ring Out connector on the protected premises side of an RJ31X block via an RJ-12 modular cable.

Connecting a PT-1S printer

For control panels with only a printer

1. Locate the printer in the same room as and within 20 ft of the panel (printer wiring is nonsupervised and power-limited).
2. Wire the printer cable to the RS232 connections on the power supply card then plug the cable into the printer.
3. Set the printer switches for 9600 bps, 8 bits, no parity. Refer to the documentation included with the printer for more details.

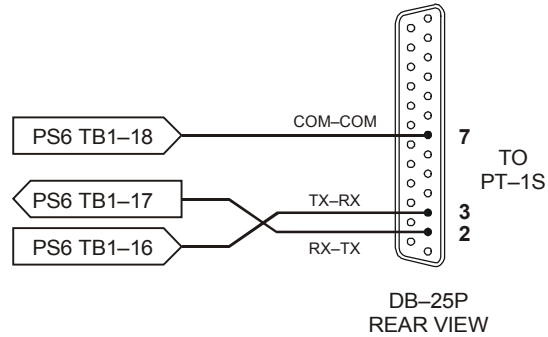

For control panels with a printer and a CDR-3 Bell Coder module

1. Install the IOP3A in the same enclosure as the CDR-3. Refer to appendix B.
2. Wire the IOP3A to the CDR-3.
3. Wire the printer cable to the RS232 connections on the IOP3A then plug the cable into the printer.
4. Configure the IOP3A as follows:
 - JP1 = 2-3
 - JP2 = ON
 - JP3 = ON
 - JP4 = ON
 - SW1 = UP
5. Set the printer switches for 9600 bps, 8 bits, no parity. Refer to the documentation included with the printer for more details.

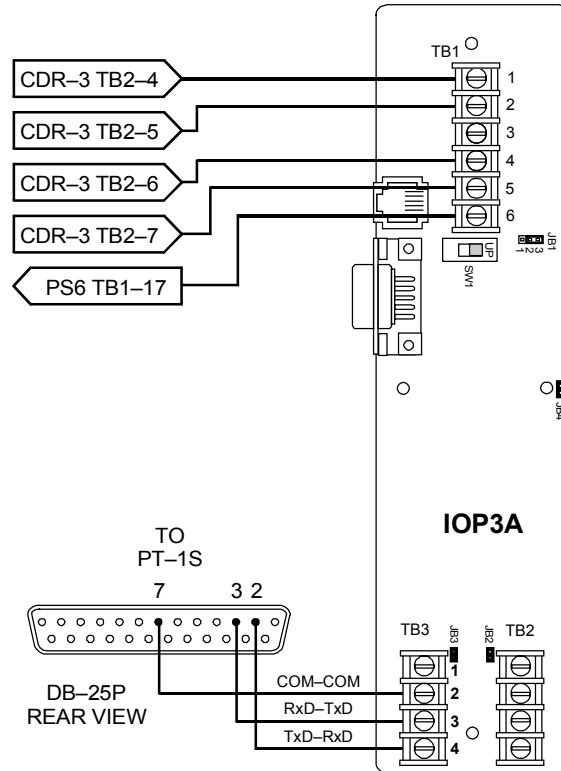

Installing standby batteries

For batteries rated at 10 Ah or less

1. Place the batteries in the bottom of the control panel.
2. Wire the batteries to the PS6.

Notes

Do not run wires through the bottom knock-outs when batteries are installed in the control panel.

Battery wiring is supervised and nonpower-limited.

Maintain a 1/4-inch separation between power-limited and nonpower-limited wiring at all times.

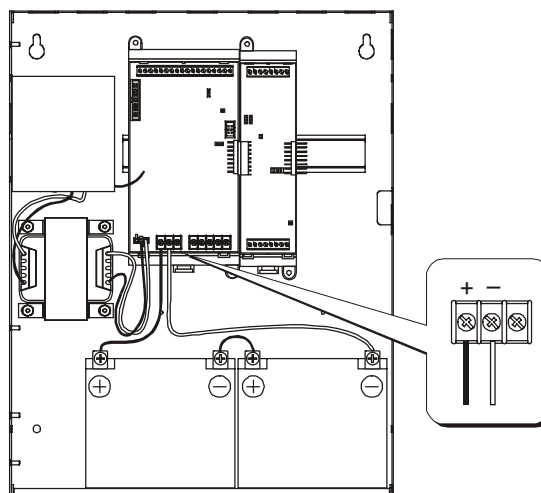

For batteries rated greater than 10 Ah

1. Place the batteries in a BC-1 Battery Cabinet. The cabinet must be mounted within 3 ft of the control panel, in the same room, and connected with conduit.
2. Wire the batteries to the PS6.

Note: Install, maintain, and test standby batteries in accordance with NFPA 72.

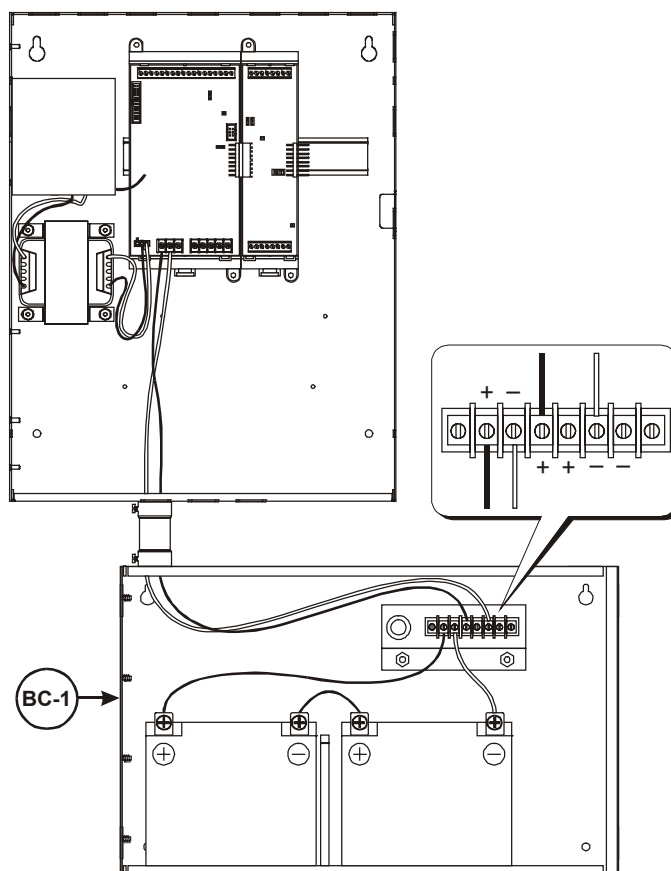

Connecting a service computer

Connection of a service computer to the control panel requires programming cable P/N 260097, ordered separately.

Connection of a service computer to a remote annunciator requires programming cable P/N 360136 and a RJ-11 to DB9 adapter P/N 240507, both ordered separately.

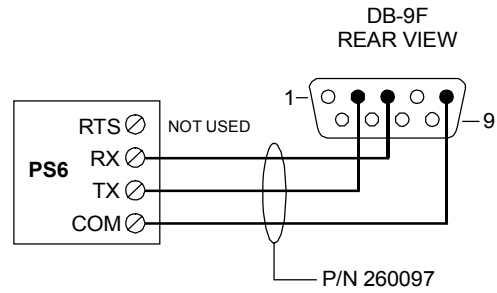

Summary

This chapter provides instructions for operating the control panel.

Content

Instructions for the Level 1 operator (public mode access) • 3.2
Instructions for the Level 2 operator (emergency mode access) • 3.5
Instructions for the Level 3 operator (maintenance mode access) • 3.7
Instructions for the Level 4 operator (service mode access) • 3.10
QuickReference list • 3.11

Instructions for the Level 1 operator (public mode access)

Tasks that do not require you to log in

What is it you want to do	This is how you do it
Silence the panel trouble buzzer	Press Panel Silence.
Get a list of all the active points on a panel	<ol style="list-style-type: none">1. Press Status.2. Choose All Active to get a list of all the active points. Choose Alarm to get a list of only the active alarm points. Choose Supervisory to get a list of only the active supervisory points. Choose Monitor to get a list of only the active monitor points.3. Press DEL to backspace the cursor then enter the panel number.4. Choose Display to view the list on the CPU/Display unit. — or — Choose Printer to print the list.
Identify points that are in trouble	<ol style="list-style-type: none">1. Press Status.2. Choose Trouble3. Press DEL to backspace the cursor then enter the panel number.4. Choose Display to view the list on the CPU/Display unit. — or — Choose Printer to print the list.
Identify active points in a Service Group that is being tested	<ol style="list-style-type: none">1. Press Status.2. Choose Test.3. Press DEL to backspace the cursor then enter the panel number.4. Choose Display to view the list on the CPU/Display unit. — or — Choose Printer to print the list.

Tasks that do not require you to log in

What is it you want to do	This is how you do it
Identify points that are disabled	<ol style="list-style-type: none"> 1. Press Status. 2. Choose Disabled Pts. 3. Press DEL to backspace the cursor then enter the panel number. 4. Choose Display to view the list on the CPU/Display unit. — or — Choose Printer to print the list.
Identify output devices that are turned on	<ol style="list-style-type: none"> 1. Press Status. 2. Choose Outputs 3. Press DEL to backspace the cursor then enter the panel number. 4. Choose Display to view the list on the CPU/Display unit. — or — Choose Printer to print the list.
Verify power supply voltage levels	<ol style="list-style-type: none"> 1. Press Status. 2. Choose Internal 3. Press Enter. 4. Choose Display to view the list on the CPU/Display unit. — or — Choose Printer to print the list.
Get a list of smoke detectors that require servicing (DIRTY attribute greater than 80%)	<ol style="list-style-type: none"> 1. Press Menu. 2. Choose Reports > Maintenance > Dirty>80%. 3. Enter the panel number. 4. Choose Display to view the list on the CPU/Display unit. — or — Choose Printer to print the list.

Tasks that do not require you to log in

What is it you want to do	This is how you do it
Get a list of smoke detectors that may require servicing (DIRTY attribute greater than 20%)	<ol style="list-style-type: none">1. Press Menu.2. Choose Reports > Maintenance > Dirty>20%.3. Enter the panel number.4. Choose Display to view the list on the CPU/Display unit. — or — Choose Printer to print the list.
Get the attributes for a single smoke detector	<ol style="list-style-type: none">1. Press Menu.2. Choose Reports > Maintenance > Single Device.3. Enter the panel number.4. Choose Display to view the list on the CPU/Display unit. — or — Choose Printer to print the list.
Get the attributes for every smoke detector on a single SLIC	<ol style="list-style-type: none">1. Press Menu.2. Choose Reports > Maintenance > Card Devices.3. Enter the panel number.4. Choose Display to view the list on the CPU/Display unit. — or — Choose Printer to print the list.
Perform a lamp test	<ol style="list-style-type: none">1. Press Menu.2. Choose Test > Lamp Test.

Instructions for the Level 2 operator (emergency mode access)

Tasks that require you to log on as a Level 2 operator

What is it you want to do	This is how you do it
Log onto the panel as a Level 2 operator	Turn the Enable Controls key 1/4 of a turn clockwise. — or — 1. Press Menu. 2. Choose Login then enter the password required for Level 2 access.
Reset the panel	Press System Reset.
Turn off alarm signaling circuits when the panel is in alarm (Alarm Silence)	Press Alarm Silence.
Turn on alarm signaling circuits when the panel is not in alarm (Drill)	Press Drill then Enter.
Get a list of all events processed on a panel	1. Press Menu. 2. Choose Reports > History. 3. Enter the panel number. 4. Choose Display to view the list on the CPU/Display unit. — or — Choose Printer to print the list.
Change the password required for Level 1 access	1. Press Menu. 2. Choose Program > Edit Password > Level 1. 3. Enter the new password.
Switch automatic detectors to their alternate sensitivity settings	1. Press Menu. 2. Choose Activate > Alt Sens.
Switch automatic detectors to their primary sensitivity settings	1. Press Menu. 2. Choose Restore > Prm Sens.

Tasks that require you to log on as a Level 2 operator

What is it you want to do	This is how you do it
Distribute event records according to their alternate message routing	<ol style="list-style-type: none">1. Press Menu.2. Choose Activate > Alt Msg Route.
Distribute event records according to their primary message routing	<ol style="list-style-type: none">1. Press Menu.2. Choose Restore > Prm Msg Route.
Disable a Zone	<ol style="list-style-type: none">1. Press Menu.2. Choose Disable > Zone.3. Select a Zone from the pick list then press Enter.
Enable a Zone	<ol style="list-style-type: none">1. Press Menu.2. Choose Enable > Zone.3. Select a Zone from the pick list then press Enter.
Disable a device	<ol style="list-style-type: none">1. Press Menu.2. Choose Disable > Device.3. Enter the device address, where: PP is the panel number (01) CC is the card number DDD is the circuit or device number
Enable a device	<ol style="list-style-type: none">1. Press Menu.2. Choose Enable > Device.3. Enter the device address, where: PP is the panel number (01) CC is the card number DDD is the circuit or device number

Instructions for the Level 3 operator (maintenance mode access)

Tasks that require you to log on as a Level 3 operator

What is it you want to do	This is how you do it
Log onto the panel as a Level 3 operator	<ol style="list-style-type: none"> 1. Press Menu. 2. Choose Login then enter the password required for Level 3 access.
Change the password required for Level 2 access	<ol style="list-style-type: none"> 1. From the Main Menu, select Program. 2. Select Edit Password. 3. Select Level 2 then enter the new password.
Get a list of all the hardware and software components installed on a panel and their revision levels	<ol style="list-style-type: none"> 1. Press Menu. 2. Choose Reports > Revision. 3. Enter the panel number. 4. Choose Display to view the list on the CPU/Display unit. — or — Choose Printer to print the list.
Set the system time and date	<ol style="list-style-type: none"> 1. Press Menu. 2. Choose Program > Time/Date. 3. Choose Enter Time, then press DEL until the display shows HHMMSS. Enter the time in 24-hour format where HH is the hour, MM is the minutes, and SS is the seconds. Example: To set the time for 1:00 p.m., enter 130000. 4. Select Enter Date. Enter the date where MM is the number of the month, DD is the date, and YYYY is the year. Example: To set the date for January 1, 2001, enter 01012001.

Tasks that require you to log on as a Level 3 operator

What is it you want to do	This is how you do it
<p>Turn on an output circuit</p> <p>Note: A typical system may assign manual override functions a high priority level, alert responses a low priority, and alarm responses a medium priority.</p>	<ol style="list-style-type: none">1. Press Menu.2. Choose Activate > Output.3. Enter the output circuit's address, where PP is the panel number, CC is the card number, and DDD is the circuit number.4. Choose Steady to change the circuit's output to always on Choose 20 BPM to change the circuit's output to a 20 beat per minute signal rate (On = 2-1/2 s; Off = 2-1/2 s). Choose 120 BPM to change the circuit's output to a 120 beat per minute signal rate (On = 1/4 s; Off = 1/4 s). Choose Temporal to change the circuit's output to a 3-3-3 pattern.5. Choose High Priority.
<p>Turn off an output circuit</p>	<ol style="list-style-type: none">1. Press Menu.2. Choose Restore > Output.3. Enter the output circuit's address, where PP is the panel number, CC is the card number, and DDD is the circuit number.4. Choose Off.
<p>Turn an LED on</p>	<ol style="list-style-type: none">1. Press Menu.2. Choose Activate > LED.3. Choose one of the following: Steady to turn the LED on Fast Blink to have the LED flash at a fast rate Slow Blink to have the LED flash at a slow rate4. Enter the LED's address where GG is the group number, SS is the switch number, and L is the LED number.
<p>Turn an LED off</p>	<ol style="list-style-type: none">1. Press Menu.2. Choose Restore > LED.3. Choose Off4. Enter the LED's address where GG is the group number, SS is the switch number, and L is the LED number.

Tasks that require you to log on as a Level 3 operator

What is it you want to do	This is how you do it
Disable or enable an And Group, Matrix Group, or Time Control	<ol style="list-style-type: none"> 1. Press Menu. 2. Choose Disable or Enable. 3. Choose And if an And group, Matrix if a Matrix group, or Time Control if a time control. 4. Pick a group from the appropriate list and press Enter.
Disable or enable a switch on a zone display	<ol style="list-style-type: none"> 1. Press Menu. 2. Choose Disable > Switch. — or — Enable > Switch. 3. Enter the switch address, where GG is the group number, and SS is the switch number.
Disable or enable the mapping function on an SLIC	<ol style="list-style-type: none"> 1. Press Menu. 2. Choose Disable > Loop Mapping. — or — Enable > Loop Mapping. 3. Enter the card address for the SLIC.
Start a Service Group test	<ol style="list-style-type: none"> 1. Press Menu. 2. Choose Test > Start Test. 3. Select a Service group from the pick list and press Enter.
<p>Cancel a Service Group test</p> <p>Note: The panel automatically resets after you cancel a test.</p>	<ol style="list-style-type: none"> 1. Press Menu. 2. Choose Test > Cancel Test. 2. Select a Service group from the pick list and press Enter.

Instructions for the Level 4 operator (service mode access)

What is it you want to do	This is how you do it
Log onto the panel as a Level 4 operator	<ol style="list-style-type: none">1. Press Menu.2. Choose Login then enter the password required for Level 4 access.
Change the password required for Level 3 access	<ol style="list-style-type: none">1. Press Menu.2. Choose Program > Edit Password > Edit Password3. Choose Level 3 then enter the new password.
Change the password required for Level 4 access	<ol style="list-style-type: none">1. Press Menu.2. Choose Program > Edit Password > Edit Password3. Choose Level 4 then enter the new password.
Restart a panel	<ol style="list-style-type: none">1. Press Menu.2. Choose Program > Restart > Panel3. Enter the panel's address.
Reset the alarm history counter	<ol style="list-style-type: none">1. From the Main Menu, select Program.2. Select Reset.3. Enter the panel's address.

QuickReference list

What is it you want to do	Required access level			
	L1	L2	L3	L4
Change smoke detector sensitivity settings to their alternate values		✓	✓	✓
Change smoke detector sensitivity settings to their primary values		✓	✓	✓
Change the current state of an LED (manual override)			✓	✓
Change the current state of an output circuit (manual override)			✓	✓
Change the password required for Level 1 access		✓	✓	✓
Change the password required for Level 2 access			✓	✓
Change the password required for Level 3 access				✓
Change the password required for Level 4 access				✓
Disable or enable a device		✓	✓	✓
Disable or enable a switch on a zone display			✓	✓
Disable or enable a zone		✓	✓	✓
Disable or enable all the devices on a single card				✓
Disable or enable an And Group, Matrix Group, or Time Control			✓	✓
Disable or enable the mapping function on an SLIC			✓	✓
Get a list of all the active points on a panel	✓	✓	✓	✓
Get a list of all the hardware and software components installed on a panel and their revision levels			✓	✓
Get a list of smoke detectors that may require servicing (DIRTY attribute greater than 20%)	✓	✓	✓	✓
Get a list of smoke detectors that require servicing (DIRTY attribute greater than 80%)	✓	✓	✓	✓
Get the attributes for a single smoke detector	✓	✓	✓	✓
Get the attributes for all the smoke detectors on a single SLIC	✓	✓	✓	✓
Identify output devices that are turned on	✓	✓	✓	✓
Identify active points in a Service Group that is being tested	✓	✓	✓	✓
Identify points that are disabled	✓	✓	✓	✓
Identify points that are in their active state	✓	✓	✓	✓
Identify points that are in trouble	✓	✓	✓	✓
Log onto the panel as a Level 2 operator		✓	✓	✓
Log onto the panel as a Level 3 operator			✓	✓
Log onto the panel as a Level 4 operator				✓
Perform a lamp test	✓	✓	✓	✓

Operating instructions

What is it you want to do	Required access level			
	L1	L2	L3	L4
Reset the alarm history counter				✓
Reset the panel		✓	✓	✓
Restart the panel				✓
Restore an LED to its previous state			✓	✓
Restore an output circuit to its previous state			✓	✓
Route off-normal signals to the alternate set of panels used to post messages		✓	✓	✓
Route off-normal signals to the primary set of panels used to post messages		✓	✓	✓
Set the system time and date			✓	✓
Silence the panel trouble buzzer	✓	✓	✓	✓
Start a Service Group test			✓	✓
Cancel a Service Group test			✓	✓
Turn off alarm signaling circuits when the panel is in alarm (Alarm Silence)		✓	✓	✓
Turn on alarm signaling circuits when the panel is not in alarm (Drill)		✓	✓	✓
Verify power supply voltage levels	✓	✓	✓	✓

Summary

This chapter provides instructions for programming the fire alarm system from the front panel. Worksheets are provided at the end of the chapter to use as programming aids and to document the system programming.

Content

Overview • 4.2
QuickStart setup instructions • 4.4
Customizing the system configuration • 4.12
Setting up an Output Group • 4.19
Setting up a Zone • 4.22

Overview

What is a Zone?

A Zone is a function in the system software that initiates an active response based on a single alarm event. Firewall designations, planned evacuation criteria, architectural design, and other factors all contribute to how the system designer divides the protected premises into zones.

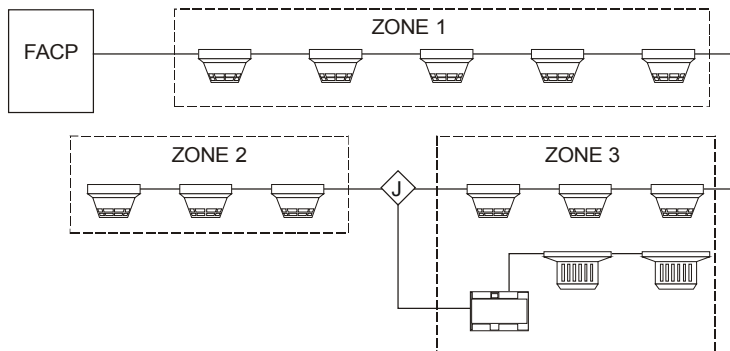

What is an Output Group?

An Output Group is a function in the system software that establishes the correlation between input circuits and responses. When an input changes states, the condition of the input determines which response the panel runs. For example, a smoke detector initiates the Active response when it signals an alarm condition but initiates the Trouble response when removed from its base.

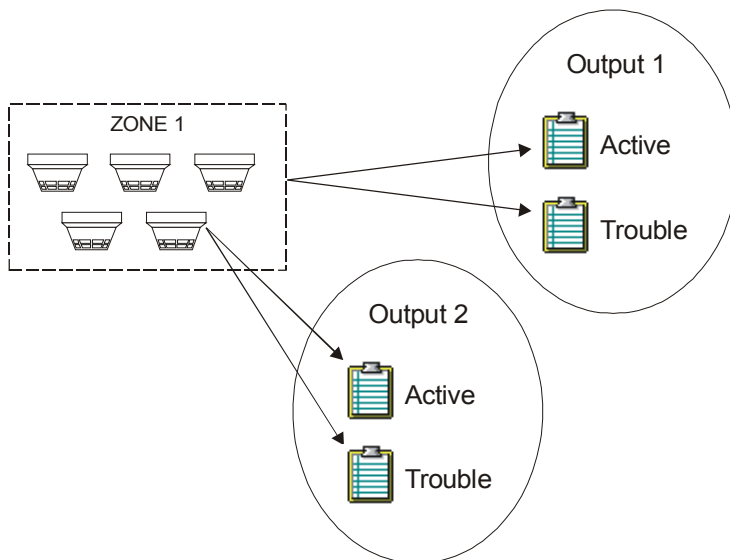

Table 4-1: Programmable features

Feature	Front Panel Programming (FPP)	Configuration Utility (CU)
And Groups	No	Yes
Output Groups	Yes	Yes
Matrix Groups	No	Yes
Service Groups	Limited	Yes
Time Controls	No	Yes
Zones	Yes	Yes
LED Configure	Limited	Yes
Switch Configure	Limited	Yes
SIGA - Prealarm	Yes	Yes
SIGA - Sensitivity levels	Yes	Yes
Alarm Verification	Yes	Yes
Coded Operation	Yes	Yes
Custom Messages	Yes (requires bar code wand)	Yes
Message Routing	No	Yes
SIGA - Diagnostics	No	Yes
AC Delay	No	Yes
Two-stage Operation	No	Yes
General Alarm Inhibit	No	Yes
Market Place	No	Yes
Card Configuration	Yes	Yes
Language	No	Yes
Zone Resound Inhibit	No	Yes
Drill Programming	No	Yes
Alarm Silence Programming	No	Yes
Waterflow Silence	No	Yes
Supervisory Duct	No	Yes
Enable Trouble Reminder	No	Yes
Auto Alarm Signal Silence	No	Yes
Alarm Signal Silence/Reset Inhibit	Yes	Yes
Panel Silence Resound Time	No	Yes
SIGA-REL	No	Yes

QuickStart setup instructions

Step 1: Read this before proceeding

Note: If at any time you get an Exception Event while programming the system, note the error code, and then contact EST Technical Services at 6411 Parkland Drive, Sarasota, FL, 34243 or at 1-800-655-4497.

To clear the Exception Event, press Alarm Silence while the event is displayed. You may have to reset the panel to display the event again.

This procedure uses the AutoLearn and AutoLoop utilities to automatically configure the system. The AutoLearn utility configures the option cards. The AutoLoop utility configures the circuits on the Signature loop.

Caution: Running the AutoLearn utility deletes the existing panel programming. If you have already programmed the system, running AutoLearn requires you to re-enter everything again from the beginning.

If you have a dialer installed, the AutoLearn utility requires you to program the DLD before exiting. Be sure to have the following:

- Subscriber account numbers, telephone numbers, and transmission formats obtained from the CMS (Central Monitoring Station). Appendix C provides a list of Contact ID event codes.
- A completed copy of the DLD Programming Worksheet (Figure 4-1).

After you have finished using the AutoLearn and AutoLoop utilities to configure the system, you can either:

- Customize the system programming
- Go to step 11 and Save and Sync.

Step 2: Apply power to the system

1. Verify that each circuit card installed in the control panel has a unique card address.
2. Apply power to the control panel and to all the remote annunciators.

After applying power, the panel CPU performs a diagnostic check in the background. You can not begin programming until this finishes and the AutoLearn option becomes available.

Step 3:
Assign Panel ID numbers to the remote annunciator panels

On each remote annunciator panel:

1. Press Menu.
2. Choose Login then enter the password required for Level 4 access (default is 4444).
3. Choose Program > Configure > AutoLearn.
4. Press Del twice then enter an unused Panel ID from 02 to 09 (01 is reserved for the control panel).
5. Enter the number of panels that are connected to the RS485 riser, including the control panel. This is your maximum number of panel addresses.
6. Select the wiring configuration of the RS485 riser (Class A or Class B) then press Enter.

Note: The wiring configuration must be the same for all panels.

Step 4:
AutoLearn the control panel.

Note: Before running the AutoLearn utility, make sure you have not installed more cards than the system allows.

On the control panel:

1. Press Menu.
2. Choose Login then enter the password required for Level 4 access (default is 4444).
3. Choose Reports > Revision > Enter > Display. Verify all the cards installed in the cabinet appear in the list.
4. Press Menu then choose Program > Configure > AutoLearn.
5. Enter 01 for the Panel ID.
6. Enter the number of panels that are connected to the RS485 riser, including the control panel. This is your maximum number of panel addresses.
7. Select the wiring configuration of the RS485 riser (Class A or Class B) then press Enter.

If you do not have a DLD card installed, the system will automatically reboot after the AutoLearn utility configures the system. Go to step 10.

If you do have a DLD card installed, go to step 5.

**Step 5:
Set up the receiver call-in
numbers and retry attempts**

1. Choose #'s of CMS then choose the number of CMS receivers that the DLD may dial into over the public switched telephone network.
2. Choose CMS Phone # then enter the telephone numbers of the CMS receivers:
 - Choose Rcvr 1 Prim # then enter the first number to try for the first CMS receiver.
 - Choose Rcvr 1 Sec # then enter the second number to try for the first CMS receiver.
 - Choose Rcvr 2 Prim # then enter the first number to try for the second CMS receiver.
 - Choose Rcvr 2 Sec # then enter the second number to try for the second CMS receiver.
 - Choose Exit.
3. Choose Retry Count then enter the number of times you want the dialer to attempt to contact the CMS receiver.

**Step 6:
Set up the subscriber
accounts**

1. Choose Accounts then <New> to set up a new account
— or —
Select an account number then press Enter.
2. Choose Account # then enter the number of the subscriber account.
3. Choose Formats then choose the required transmission format.
4. Choose Test–Normal then enter the character string to send when the control panel is normal.
5. Choose Test–Abnormal then enter the character string to send when the control panel is off-normal.
6. Choose Test Time then enter when you want the dialer to transmit the test string in 24-hour format.
7. Choose CMS then choose which CMS receiver to dial.
This is the receiver that holds the account.
8. Choose Exit.

**Step 7:
Edit the default alarm
messages**

Note: The dialer automatically sends the default alarm message for active alarm inputs that are not programmed to initiate a dialer response.

1. Choose Default Msgs > Alarm.
2. Choose Account then select the subscriber account you want to receive the message.
3. Choose Active Msg then enter the message you want sent for alarm activation events.
For example, for Contact ID enter 111000000
4. Choose Restore Msg then enter the message you want sent for alarm restoration event.
For example, for Contact ID enter 311000000
5. Choose Exit.

**Step 8:
Edit the default trouble
messages**

Note: The dialer automatically sends the default trouble message for inputs that signal a trouble but are not programmed to initiate a dialer response.

1. Choose Default Msgs > Trouble.
2. Choose Account then select the subscriber account you want to receive the message.
3. Choose Active Msg then enter the message you want sent for trouble activation events.
For example, for Contact ID enter 130000000
4. Choose Restore Msg then enter the message you want sent for trouble restoration event.
For example, for Contact ID enter 330000000
5. Choose Exit.

**Step 9:
Edit the default supervisory
messages**

Note: The dialer automatically sends the default supervisory message for active supervisory inputs that are not programmed to initiate a dialer response.

1. Choose Default Msgs > Supervisory.
2. Choose Account then select the subscriber account you want to receive the message.
3. Choose Active Msg then enter the message you want sent for supervisory activation events.
For example, for Contact ID enter 120000000
4. Choose Restore Msg then enter the message you want sent for a supervisory restoration event.
For example, for Contact ID enter 220000000
5. Choose Exit.

Step 10: AutoLoop the loop controller cards

Run the AutoLoop utility on each loop controller installed in the control panel.

Caution: When the system reboots, the loop controller reinitializes the loop. If you attempt to run the AutoLoop utility during this time, you could corrupt the project database.

1. On the control panel, press Menu.
2. Choose Login then enter the password required for Level 4 access.
3. Choose Program > Configure.
If the loop is still initializing, do not proceed until loop initialization has finished.
4. Choose Cards > Edit, then enter the card number for the loop controller.
5. On the Edit Cards menu, choose AutoLoop.
6. If the number of detector and module addresses on the display match the number installed on the loop, press Enter to accept, then wait while the database is updated.
If not, press Del to cancel. You must correct the problem before continuing with this loop.
7. On the SLIC menu, choose Exit.
8. For each additional loop controller, repeat steps 4–7.
9. Choose Exit.

Step 11: Saving the project database

Tip: Only Save and Sync after you have finished programming the control panel and you want to update the project databases in the remote annunciators.

At this point, you have configured the project database for a general alarm system. Refer to Table 4-2, Table 4-3, and Table 4-4 for initial system settings.

If you want to accept the general alarm system configuration, choose Save and Sync.

If you want to make changes to the system configuration, choose Save, and then make your changes. See Customizing the system configuration. After making all of your changes:

1. Press Menu.
2. Choose Login then enter the password required for Level 4 access.
3. Choose Program > Configure > Exit.
4. Choose Save and Sync.

Note: If the local AHJ requires a hard copy of your site programming, use the QuickStart Configuration Utility to retrieve the database from the panel and print the required information.

Table 4-2: AutoLearn initial project settings

Option	Value	Description	Edit?
Alarm Silence	Audible only	Turns off Audible and Common Alarm Output circuits when someone presses Alarm Silence.	CU
Drill	Audible only	Turns off Audible and Common Alarm Output circuits when someone presses Drill.	CU
Drill Activation Type	Steady	The Drill signal is a constant signal.	CU
Alarm Signal Silence/Reset Inhibit	None	Alarm Silence or Reset functions are not inhibited. You can turn off (silence) notification circuits or reset the panel any time after notification circuits are activated.	FPP/CU
Buzzer Reminder Time	Indefinitely	The panel trouble buzzer remains silenced until the control panel processes a new off-normal signal.	No
AC Power Trouble Delay	6 h	The panel will operate on battery power for 6 hours before signaling a trouble condition.	FPP/CU
Two-stage Timer	0 s (UL) 300 s (ULC)	The panel will turn on notification circuits immediately after processing an alarm signal (UL) or after 5 minutes (ULC).	CU
Zone Resound Inhibit	No	Turn silenced NAC circuits back on if an active alarm input circuit remains in the active condition after resetting the panel.	No
Primary Routing	All Cabinets	Distribute event records to all panels in the system when primary routing is activated.	CU
Alternate Routing	All Cabinets	Distribute event records to all panels in the system when alternate routing is activated.	CU
Language	English (U.S.)	U.S. English displayed on CPU/Display.	No
Relay 1 Type	Alarm	Alarm events cause the contact positions of Relay 1 on the PS6 to change positions.	No
Relay 2 Type	Supervisory	Supervisory events cause the contact positions of Relay 2 on the PS6 to change positions.	No
Relay 3 Type	Trouble	Trouble events cause the contact positions of Relay 3 on the PS6 to change positions.	No
Relay 4 Type	Monitor	Monitor events cause the contact positions of Relay 4 on the PS6 to change positions.	CU

Table 4-3: AutoLearn initial card configuration settings

Card	Circuit	Address	Device type	Edit?	Diagram
SLIC	NAC 1	270	Visible	FPP/CU	<p>The diagram shows a vertical card with two terminal blocks at the top. The left terminal block is labeled 'NAC 1' and the right terminal block is labeled 'NAC 2'. The card also features a connector on the left side, a multi-pin connector on the right side, and two small square components on the front panel.</p>
	NAC 2	271	Common Alarm Output	FPP/CU	

Table 4-4: AutoLoop initial settings for SIGA devices

SIGA Device	Personality	Description	Device Type	Edit?
SIGA-IPHS, -PHS, -PS, -IS	none	Smoke detector settings as follows: Sensitivity: Least Verification: None Prealarm: None	Alarm	FPP/CU
SIGA-HFS, HRS, -IM	none	Heat detector settings not programmable	Alarm	FPP/CU
Single-stage pull stations	01	Class B Alarm Latching	Pull	FPP/CU
Dual-stage pull stations	01	Class B Alarm Latching	Monitor	FPP/CU
	01	Class B Alarm Latching	Pull	FPP/CU
SIGA-APS	03	Class B Active Non-Latching	Monitor	FPP/CU
	03	Class B Active Non-Latching	Monitor	FPP/CU
SIGA-(M)CC1(S)	05	Riser selector	Common Alarm Output	FPP/CU
SIGA-(M)CC2	07	Dual riser selector	Common Alarm Output	FPP/CU
SIGA-(M)CR(R)	08	Dry contact	Nonsupervised Output	FPP/CU
SIGA-(M)CT1	01	Class B Alarm Latching	Alarm	FPP/CU
SIGA-(M)CT2	01	Class B Alarm Latching	Alarm	FPP/CU
	01	Class B Alarm Latching	Alarm	FPP/CU
SIGA-DTS	01	Class B Alarm Latching	Alarm	FPP/CU
SIGA-IO	31	Monitor Input/Output N.O.	Monitor	FPP/CU
SIGA-MAB	00	Class A Signal Output	Monitor	FPP/CU
	00	not used		
SIGA-UM	00	Class A Signal Output	Monitor	FPP/CU
	00	not used		
SIGA-MM1	03	Class B Active Non-Latching	Monitor	FPP/CU
SIGA-WTM	02	Class B Active Latching - Delayed	Alarm	FPP/CU
	04	Class B Active Latching.	Supervisory	FPP/CU
SIGA-(M)RM1	23	Riser monitor - 24 Vdc	Monitor	FPP/CU

Note: If you use Signature devices from another system, the AutoLoop utility uses the attributes programmed from the previous system as the initial settings for a general alarm system.

Customizing the system configuration

You can customize the system configuration, if your requirements exceed that of the general alarm system created using the AutoLearn and AutoLoop utilities.

Before you can make any changes to the system programming, you must log onto the system to start an editing session.

The control panel has a watchdog timer that kicks you out of an editing session after a period of inactivity. If this happens, you will have to log in again to continue.

After you finish customizing the system configuration, save your changes, and then test the system. After everything checks out then Save and Sync to copy the database to the remote annunciators.

WARNING: Entering Edit mode (choosing Configure on the Program menu) disables the control panel and leaves the premises unprotected until you exit Edit mode.

To start an editing session:

1. Press Menu.
2. Choose Login then enter the password required for Level 4 access.
3. Choose Program > Configure.

What is it you want to do	This is how you do it
<p>Make information about the installer available on the CPU/Display</p> <p>AutoLearn default: No text</p>	<ol style="list-style-type: none"> 1. On the Configure menu, choose System > User Labels. 2. Choose Facility Name, scan in the name of the project, and then press Enter. 3. Choose Inst Company, scan in the name of the installing company, and then press Enter. 4. Choose Phone Number, scan in the telephone number to call for service-related issues, and then press Enter. 5. Choose Programmer, scan in the name of the person that programmed the system, and then press Enter. 6. Choose Exit.
<p>Set how long notification circuits must stay on before pressing Alarm Silence can turn them off or pressing Reset can reset the panel</p> <p>AutoLearn default: None (no delay)</p>	<ol style="list-style-type: none"> 1. On the Configure menu, choose System > ALM/RST Inhib. 2. Select a time delay from the pick list then press Enter.
<p>Set how long the panel must wait before signaling an ac power failure</p> <p>AutoLearn default: 0 (no delay)</p>	<ol style="list-style-type: none"> 1. On the Configure menu, choose System > AC Power Dly. 2. Select a time delay from the pick list then press Enter.

What is it you want to do	This is how you do it
<p>Change the device type of the NAC circuits on the SLIC.</p> <p>AutoLearn defaults: NAC1 device type is Visible; NAC 2 device type is Common Alarm Output</p> <p>Common Alarm Output circuits turn on automatically when an input signals an alarm event. Visible and Audible output circuits must be placed in an Output Group in order to turn them on. The AutoLearn utility automatically places Visible circuits in an Output Group</p>	<hr/> <hr/> <p>WARNING: Changing an output circuit from a Common Alarm Output device type to an Audible device type does not automatically place the Audible circuit in an Output Group. You must add the Audible Circuit to the Output Group manually or the Audible circuit will not turn on.</p> <hr/> <hr/> <ol style="list-style-type: none"> 1. On the Configure menu, choose Cards > Edit then enter the card address number. 2. Choose Config Card. 3. Choose NAC 1 then choose the device type for NAC 1. 4. Choose NAC 2 then choose the device type for NAC 2. 5. Choose Exit > Save Edits, then wait while the database is updated.
<p>Change the performance class of the Signature loop wiring</p> <p>AutoLearn default: Wiring is Class B.</p>	<ol style="list-style-type: none"> 1. On the Configure menu, choose Cards > Edit then enter the card address number. 2. Choose Config Card. 3. Choose Wiring Class then choose how the loop is wired to the SLIC. 4. Choose Exit > Save Edits, then wait while the database is updated.
<p>Enter location message text for an automatic detector</p>	<ol style="list-style-type: none"> 1. On the Configure menu, choose Cards > Edit and then enter the card address number of the loop controller. 2. Choose Config Detect > Edit > Enter Serial # and then scan or enter the detector's serial number. 3. Choose Message then scan in the text that you want sent when the detector signals an event. 4. Choose Exit > Save Edits.

What is it you want to do	This is how you do it
Change the Alarm Sensitivity setting of a smoke detector	<hr/> <hr/> WARNING: Selection of the appropriate detector technology and sensitivity settings should result from a careful analysis of the hazard, environmental conditions, and expected results. <hr/> <hr/> <ol style="list-style-type: none">1. On the Configure menu, choose Cards > Edit and then enter the card address number of the loop controller.2. Choose Config Detect > Edit > Enter Serial # and then scan or enter the detector's serial number.3. Choose Sensitivity then choose the alarm sensitivity setting you want the detector to use. Refer to Table 4-5 and Table 4-6.4. Choose Exit > Save Edits.
Change the Alarm Verification setting of a smoke detector	<ol style="list-style-type: none">1. On the Configure menu, choose Cards > Edit and then enter the card address number of the loop controller.2. Choose Config Detect > Edit > Enter Serial # and then scan or enter the detector's serial number.3. Choose Verification then choose the length of the alarm verification period.4. Choose Exit > Save Edits.
Change the Prealarm setting of a smoke detector	<hr/> <hr/> WARNING: Prealarm obscuration levels below 80% should not be used without full knowledge of the possible consequences. <hr/> <hr/> <ol style="list-style-type: none">1. On the Configure menu, choose Cards > Edit and then enter the card address number of the loop controller.2. Choose Config Detect > Edit > Enter Serial # and then scan or enter the serial number of the detector.3. Choose Pre-Alarm then choose the warning threshold setting you want the detector to use. Refer to Table 4-5 and Table 4-6.4. Choose Exit > Save Edits.

Table 4-5: %Obscuration levels for SIGA-IPHS, SIGA-PS, and SIGA-PHS

	Alarm Obscuration Levels				
Sensitivity Settings	Most	More	Normal	Less	Least
%Obscuration	1.00%	2.00%	2.50%	3.00%	3.50%
Prealarm Settings	Prealarm Obscuration Levels				
95%	0.95%	1.90%	2.38%	2.85%	3.33%
90%	0.90%	1.80%	2.25%	2.70%	3.15%
85%	0.85%	1.70%	2.13%	2.55%	2.98%
80%	0.80%	1.60%	2.00%	2.40%	2.80%
75%	0.75%	1.50%	1.88%	2.25%	2.63%
70%	0.70%	1.40%	1.75%	2.10%	2.45%
65%	0.65%	1.30%	1.63%	1.95%	2.28%
60%	0.60%	1.20%	1.50%	1.80%	2.10%
55%	0.55%	1.10%	1.38%	1.65%	1.93%
50%	0.50%	1.00%	1.25%	1.50%	1.75%
45%	0.45%	0.90%	1.13%	1.35%	1.58%
40%	0.40%	0.80%	1.00%	1.20%	1.40%
35%	0.35%	0.70%	0.88%	1.05%	1.23%
30%	0.30%	0.60%	0.75%	0.90%	1.05%
25%	0.25%	0.50%	0.13%	0.31%	0.88%
20%	0.20%	0.40%	0.50%	0.60%	0.70%
15%	0.15%	0.30%	0.38%	0.45%	0.53%
10%	0.10	0.20%	0.25%	0.30%	0.35%
5%	0.05	0.10%	0.13%	0.15%	0.18%
Note: Shaded prealarm settings not available for SIGA-IPHS					

Table 4-6: %Obscuration levels for SIGA-IS

	Alarm Obscuration Levels				
Sensitivity Settings	Most	More	Normal	Less	Least
%Obscuration	0.7%	1.00%	1.20%	1.40%	1.6%
Prealarm Settings	Prealarm Obscuration Levels				
95%	0.67%	0.95%	1.14%	1.33%	1.52%
90%	0.63%	0.90%	1.08%	1.26%	1.44%
85%	0.60%	0.85%	1.02%	1.19%	1.36%
80%	0.56%	0.80%	0.96%	1.12%	1.28%
75%	0.53%	0.75%	0.90%	1.05%	1.20%
70%	0.49%	0.70%	0.84%	0.98%	1.12%
65%	0.46%	0.65%	0.78%	0.91%	1.04%
60%	0.42%	0.60%	0.72%	0.84%	0.96%
55%	0.39%	0.55%	0.66%	0.77%	0.88%
50%	0.35%	0.50%	0.60%	0.70%	0.80%

What is it you want to do	This is how you do it
<p>Enter location message text for a circuit on a SIGA module</p>	<ol style="list-style-type: none">1. On the Configure menu, choose Cards > Edit and then enter the card address number of the loop controller.2. Choose Config Module > Edit > Enter Serial # and then scan or enter the serial number of the module.3. For a single-address module or the first address of a dual-address module, choose Device 1. — or — For the second address of a dual-address module, choose Device 2.4. Choose Message, scan in the text, and then press Enter.5. Choose Exit.
<p>Change the device type for a circuit on a SIGA module</p> <p>Note: The device types shown in the pick lists vary depending on the SIGA module. The device types shown in the pick lists for the second address of a dual-address module also vary depending on the device type chosen for the first address.</p>	<ol style="list-style-type: none">1. On the Configure menu, choose Cards > Edit and then enter the card address number of the loop controller.2. Choose Config Module > Edit > Enter Serial # and then scan or enter the serial number of the module.3. For a single-address module or the first address of a dual-address module, choose Device 1. — or — For the second address of a dual-address module, choose Device 2.4. Choose Type, select a device type from the pick list, and then press Enter.5. Choose Exit.

What is it you want to do	This is how you do it
<p>Change the personality code for a circuit on a SIGA module</p> <p>Note: The personality codes shown in the pick lists vary depending on the SIGA module and the chosen device type.</p>	<ol style="list-style-type: none"> 1. On the Configure menu, choose Cards > Edit and then enter the card address number of the loop controller. 2. Choose Config Module > Edit > Enter Serial # and then scan or enter the serial number of the module. 3. For a single-address module or the first address of a dual-address module, choose Device 1. — or — For the second address of a dual-address module, choose Device 2. 4. Choose Personality, select a personality code from the pick list, and then press Enter. 5. Choose Exit.
<p>Enable the loop controller mapping function</p> <p>AutoLearn default: Mapping disabled</p>	<ol style="list-style-type: none"> 1. Press Menu. 2. Log onto the panel as a Level 4 operator. 3. Choose Enable > Loop Mapping. 4. Enter the card number of the SLIC that connects to the device you want to replace. Wait until mapping finishes before continuing. 5. Choose Cards > Edit. 6. Enter the card number of the SLIC that connects to the device you want to replace. 7. Choose Accept Map. If actual and expected data for detectors and modules are the same, press Enter. 8. Choose Exit > Exit > Save.

Table 4-7: Device type descriptions

Alarm	Device type assigned to IDC circuits that connect to automatic or a combination of automatic and manual alarm-signal initiating devices. Alarm circuits signal Alarm Active events.
Alarm Output	Device type assigned to IDC/NAC circuits that connect to notification appliances that you want turned on automatically when the panel processes an alarm signal. Alarm Output circuits turn off when you press Alarm Silence and turn on when you press Drill.
Audible	Device type assigned to IDC/NAC circuits that connect to audible notification appliances (horns). Audible circuits turn off when you press Alarm Silence and turn on when you press Drill.
Heat	Device type assigned to IDC circuits that connect to automatic alarm-signal initiating devices that detect a rise in the surrounding temperature. Heat circuits signal Heat Alarm events.
Monitor	Device type assigned to IDC circuits that connect to monitor-signal initiating devices that monitor the operation of ancillary system functions. Monitor circuits signal Monitor events.
Output	Device type assigned to IDC/NAC circuits that supervise their output wiring for opens and shorts. Output circuits do not turn off when you press Alarm Silence or turn on when you press Drill.
Pull	Device type assigned to IDC circuits that connect to manually operated alarm-signal initiating devices. Pull circuits signal Pull Station events.
Supervisory	Device type assigned to IDC circuits that connect to supervisory-signal initiating devices that detect abnormal conditions that could make the sprinkler system inoperative or ineffective. Supervisory circuits signal Supervisory events.
Tamper	Device type assigned to IDC circuits that connect to supervisory-signal initiating devices that detect when someone tampers with a component of the sprinkler system. Tamper circuits signal Tamper events.
Verified Smoke	Device type assigned to IDC circuits that connect to automatic alarm-signal initiating devices that use alarm verification. Verified Smoke circuits signal Alarm Verify events when the fire condition is first detected then Alarm Active events after verifying the fire condition exists.
Visible	Device type assigned to IDC/NAC circuits that connect to visual notification appliances (strobes). Visible circuits do not turn off when you press Alarm Silence or turn on when you press Drill unless programmed to do so.
Water Flow	Device type assigned to IDC circuits that connect to alarm-signal initiating devices that detect water flowing through the sprinkler system. Water Flow circuits signal Waterflow events.

Setting up an Output Group

Before you begin

Before you begin, you should complete an Output Group Programming Worksheet (Figure 4-6) for each Output group. Keep a copy for your records.

To set up an Output Group:

1. On the control panel, press Menu.
2. Choose Login then enter the password required for Level 4 access.
3. Choose Program > Configure > Output.
4. To program a new Output group, choose Add.

— or —

To edit an existing Output group, choose Edit, select the group from the pick list, and then press Enter.

5. Add the responses.
6. After you finish entering the responses, you should review them to make sure they are correct.

Adding a response that activates an output circuit

1. Choose Responses.
2. Choose Active or Trouble
3. Choose Add > Relay, then enter the circuit address where CC is the card number and DDD is the circuit number.
4. Choose the activation setting.
5. Choose Exit > Save Edits.

Adding a response that activates a delay

1. Choose Responses.
2. Choose Active or Trouble.
3. Choose Add > Delay.
4. Choose Delay Type, then choose when to initiate the delay response.
5. Choose Delay Time, press Del four times, and then enter how many seconds you want the delay to last.
6. Choose Exit > Save Edits.

Programming instructions

Adding a response that sends a dialer string

1. Choose Responses.
2. Choose Active or Trouble.
3. Choose Add > Dialer.
4. Select an account number from the pick list, and then press Enter.
5. Choose Send On, select when to send the dialer string from the pick list, and then press Enter.
6. Choose Priority, select the priority classification from the pick list, and then press Enter.
7. Choose String, then enter the message you want sent.
8. Choose Exit > Save Edits.

Reviewing your responses

1. Choose Review.
2. Choose Active to review the active responses.
— or —
Choose Trouble to review the trouble responses.

Table 4-8: Response code definitions

Response	Description
PppCccDddd 1234	<p>This is what the panel display looks like when you review a response for an output circuit.</p> <p>P:pp C:cc D:ddd is the address of the of the output circuit (P = panel number, C = card number, D = device number)</p> <p>1 is the command direction (B = Both activation and restoration, A = Activation only, R = Restoration only)</p> <p>2 is the command (N = no operation, A = Activate, E = Enable, R = Restore, I = Disable, D = Delay)</p> <p>3 is the priority attribute (S = Set, A = Latch, L = Low, M = Medium, H = High)</p> <p>4 is the command attribute (S = Set, R = Reset, W = 20 bpm, F = 120 bpm, T = Temporal)</p>
PppCccDddd 1234	<p>This is what the panel display looks like when you review a response for an LED.</p> <p>P:pp C:cc D:ddd is the address of the of the output circuit (P = panel number, C = card number, D = device number)</p> <p>1 is the command direction (B = Both activation and restoration, A = Activation only, R = Restoration only)</p> <p>2 is the command (N = no operation, A = Activate, E = Enable, R = Restore, I = Disable, D = Delay)</p> <p>3 is the priority attribute (S = Set, A = Latch, L = Low, M = Medium, H = High)</p> <p>4 is the command attribute (S = Steady, R = Restore, W = Slow Blink, F = Fast Blink)</p>
Delay: ssss 1	<p>This is what the panel display looks like when you review a response for delay.</p> <p>ssss is the amount of delay in seconds</p> <p>1 is the command direction (B = Both activation and restoration, A = Activation only, R = Restoration only)</p>
ACCT12QEEEGPPP — or — ACCT12PP	<p>This is what the panel display looks like when you review a response for dialer string.</p> <p>ACCT is the 4-digit subscriber account number (0000–9999)</p> <p>1 is the priority attribute (L = Life Safety, P = Property, S = System Integrity)</p> <p>2 s the command direction (B = Both activation and restoration, A = Activation only, R = Restoration only)</p> <p>For Contact ID dialer strings:</p> <p>Q is the event qualifier (1 = activation event, 3 = restoration event)</p> <p>EEE is the event code. See Table 4-9.</p> <p>GGPPP is the point being reported</p> <p>For 4/2 dialer strings:</p> <p>PP is the point being reported (00–99)</p>

Table 4-9: Contact ID Event Codes

100 – Medical alarm	155 – Foil break	350 and 360 – Communication Trouble
101 – Pendant transmitter	156 – Day trouble	351 – Telco 1 fault
102 – Fail to report in	157 – Low bottled gas level	352 – Telco 2 fault
110– Fire Alarm	158 – High temperature	353 – Long range radio
111 – Smoke	159 – Low temperature	354 – Fail to communicate
112 – Combustion	161 – Loss of air flow	355 – Loss of radio supervision
113 – Water Flow	200 and 210 – Fire Supervisory	356 – Loss of central polling
114 – Heat	201 – Low water pressure	370 – Protection Loop Trouble
115 – Pull Station	202 – Low CO ₂	371 – Protection loop open
116 – Duct	203 – Gate valve sensor	372 – Protection loop short
117 – Flame	204 – Low water level	373 – Fire trouble
118 – Near alarm	205 – Pump activated	380 – Sensor Trouble
120 – Panic Alarm	206 – Pump failure	381 – Loss of supervisory (RF)
121 – Duress	300 and 310 – System Troubles	382 – Loss of supervisory (RPM)
122 – Silent	301 – AC loss	383 – Sensor tamper
123 – Audible	302 – Low system battery	384 – RF transmitter low battery
130 – Burglar Alarm	303 – RAM checksum bad	400 – Open/Close
131 – Perimeter	304 – ROM checksum bad	401 – Open/Close by user
132 – Interior	305 – System reset	402 – Group open/close
133 – 24 Hour	306 – Panel program changed	403 – Automatic open/close
134 – Entry/Exit	307 – Self-test failure	404 – Late to open/close
135 – Day/Night	308 – System shutdown	405 – Deferred open/close
136 – Outdoor	309 – Battery test failure	406 – Cancel
137 – Tamper	310 – Ground fault	407 – Remote arm/disarm
138 – Near alarm	320 – Sounder/Relay Trouble	408 – Quick arm
140 – General Alarm	321 – Bell 1	409 – Keypad open/close
141 – Polling loop open	322 – Bell 2	410 – Remote Access
142 – Polling loop short	323 – Alarm relay	411 – Call request made
143 – Expansion module failure	324 – Trouble relay	412 – Success – Download access
144 – Sensor tamper	325 – Reversing	413 – Unsuccessful access
145 – Expansion module failure	330 and 340 – System Peripheral Trouble	414 – System shutdown
150 and 160 – 24-hour Non-Burglary	331 – Polling loop open	415 – Dialer shutdown
151 – Gas detection	332 – Polling loop short	
152 – Refrigeration	333 – Expansion module failure	
153 – Loss of heat	334 – Repeater failure	
154 – Water leakage	335 – Local printer paper out	
	336 – Local printer failure	

Table 4-9: Contact ID Event Codes (cont.)

420 – Access Control	600 – Test/Misc.
421 – Access denied	601 – Manual trigger test
422 – Access report by user	602 – Periodic test report
441 – Stay arming	603 – Periodic RF transmission
451 – Early opening/closing	604 – Fire test
452 – Late opening/closing	605 – Status report to follow
453 – Late to open	606 – Listen–in follow
454 – Late to close	607 – Walk Test mode
455 – Auto–arm failure	621 – Event Log reset
500 and 510 – System Disable	622 – Event Log 50% full
520 – Sounder/Relay Disable	623 – Event Log 90% full
521 – Bell 1 disable	624 – Event log overflow
522 – Bell 2 disable	625 – Time/Date reset
523 – Alarm relay disable	626 – Time/Date inaccurate
524 – Trouble relay disable	627 – Program mode entry
525 – Reversing relay disable	628 – Program mode exit
530 and 540 – System Peripheral Disable	631 – Exception schedule change
550 and 560 – Communication Disable	
551 – Dialer disable	
552 – Radio transmitter	
570 – Disable Bypasses	
570 – Zone bypass	
571 – Fire zone bypass	
572 – 24 Hour zone bypass	
573 – Burglary zone bypass	
574 – Group bypass	

Setting up a Zone

Before you begin

Before you begin, you should complete a Zone Programming Worksheet (Figure 4-7) for each Zone. Keep a copy for your records. You will also need to refer to the Output Group programming worksheets.

To set up a Zone:

1. On the control panel, press Menu.
2. Choose Login then enter the password required for Level 4 access.
3. Choose Program > Configure > Zone.
4. To program a new Zone, choose Add, and then choose a zone type (Alarm, Supervisory, or Monitor).

— or —

Choose Edit, select an existing zone from the pick list, and then press Enter.

Configure the Zone

1. Choose Message, scan in the message text, and then press Enter.
2. Choose Members, then for each device that comprises the Zone:

Choose Device Address, then enter the member's device number from the worksheet

— or —

Choose Enter Serial#, scan in or enter the member's serial number.

3. Choose Review to verify which devices you added to the Zone. If you added any devices in error, delete them.
4. Choose Output Group > Add, then select the Output group from the pick list that contains the responses you want activated, and then press Enter.
Repeat for each Output group you want to add.
5. Choose Review to verify which Output groups you added to the Zone. If you added any Output groups in error, remove them.
6. For coded systems, choose Coding, and then enter the Zone Code.

Job Name: _____

Page ____ of ____

Panel: _____ Card: 14

of CMS receivers: 1 2

CMS phone numbers: Receiver 1: #1) _____ Receiver 1: #2) _____
Receiver 2: #1) _____ Receiver 2: #2) _____

Retry Count: 5 6 7 8 9 10

Account Number: _ _ _ _ _ Format: 4/2 Contact ID
Test strings: Panel normal: _____ Panel off-normal: _____
Time: _ _ _ _ _ CMS receiver to dial: 1 2

Account Number: _ _ _ _ _ Format: 4/2 Contact ID
Test strings: Panel normal: _____ Panel off-normal: _____
Time: _ _ _ _ _ CMS receiver to dial: 1 2

Account Number: _ _ _ _ _ Format: 4/2 Contact ID
Test strings: Panel normal: _____ Panel off-normal: _____
Time: _ _ _ _ _ CMS receiver to dial: 1 2

Account Number: _ _ _ _ _ Format: 4/2 Contact ID
Test strings: Panel normal: _____ Panel off-normal: _____
Time: _ _ _ _ _ CMS receiver to dial: 1 2

Account Number: _ _ _ _ _ Format: 4/2 Contact ID
Test strings: Panel normal: _____ Panel off-normal: _____
Time: _ _ _ _ _ CMS receiver to dial: 1 2

Account Number: _ _ _ _ _ Format: 4/2 Contact ID
Test strings: Panel normal: _____ Panel off-normal: _____
Time: _ _ _ _ _ CMS receiver to dial: 1 2

Account Number: _ _ _ _ _ Format: 4/2 Contact ID
Test strings: Panel normal: _____ Panel off-normal: _____
Time: _ _ _ _ _ CMS receiver to dial: 1 2

Account Number: _ _ _ _ _ Format: 4/2 Contact ID
Test strings: Panel normal: _____ Panel off-normal: _____
Time: _ _ _ _ _ CMS receiver to dial: 1 2

Figure 4-1: DLD Programming Worksheet (sheet 1 of 2)

Programming instructions

Job Name: _____

Page ____ **of** ____

Panel: _____ **Card: 14**

Default Alarm Message: Account Number: _ _ _ _
 Active Message: _____
 Restore Message: _____

Default Trouble Message: Account Number: _ _ _ _
 Active Message: _____
 Restore Message: _____

Default Supervisory Message: Account Number: _ _ _ _
 Active Message: _____
 Restore Message: _____

Figure 4-1 DLD Programming Worksheet (sheet 1 of 2)

Job Name: _____

Page ____ of ____

Panel: _____ Card: _____

001 NC (normally-closed)
 NO (normally-open)
 Device type: _____

002 NC (normally-closed)
 NO (normally-open)
 Device type: _____

003 NC (normally-closed)
 NO (normally-open)
 Device type: _____

004 NC (normally-closed)
 NO (normally-open)
 Device type: _____

005 NC (normally-closed)
 NO (normally-open)
 Device type: _____

006 NC (normally-closed)
 NO (normally-open)
 Device type: _____

007 NC (normally-closed)
 NO (normally-open)
 Device type: _____

008 NC (normally-closed)
 NO (normally-open)
 Device type: _____

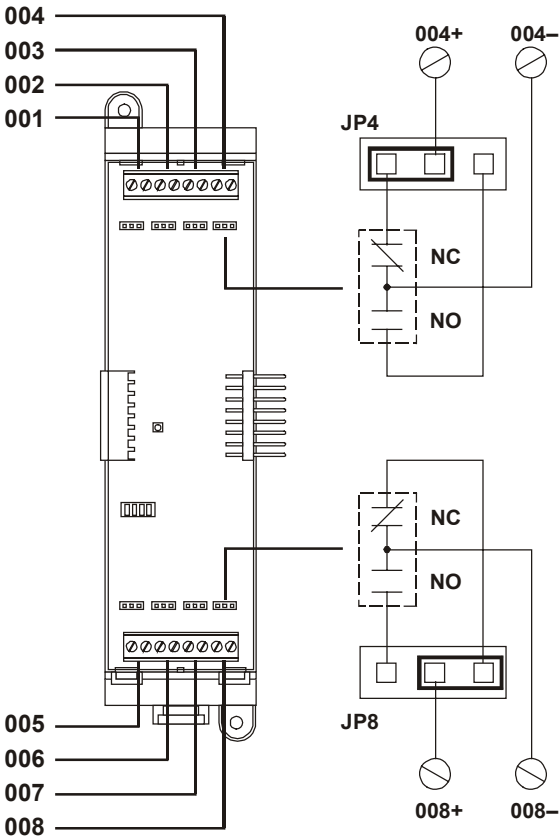

Figure 4-2: ZA8-2 Programming Worksheet

Job Name: _____

Page ____ **of** ____

Panel: _____

Card: _____

NAC 1 device type: Audible Visible NAC 2 device type: Audible Visible

Wiring class: Class A Class B

Number of detector addresses used on loop: _____

Number of module addresses used on loop: _____

Card: _____

NAC 1 device type: Audible Visible NAC 2 device type: Audible Visible

Wiring class: Class A Class B

Number of detector addresses used on loop: _____

Number of module addresses used on loop: _____

Card: _____

NAC 1 device type: Audible Visible NAC 2 device type: Audible Visible

Wiring class: Class A Class B

Number of detector addresses used on loop: _____

Number of module addresses used on loop: _____

Card: _____

NAC 1 device type: Audible Visible NAC 2 device type: Audible Visible

Wiring class: Class A Class B

Number of detector addresses used on loop: _____

Number of module addresses used on loop: _____

Figure 4-3: SLIC Programming Worksheet

Job Name: _____

Page ____ of ____

Panel: _____ Card: _____

Model: _____ S/N _____ Device: _____

Sensitivity: Most More Normal Less Least

Verification: None 12 s 24 s 36 s 60 s

Pre-Alarm: None 20% 40% 60% 80%

Base type: Standard Relay Isolator

Message: 1) _____ 2) _____

Model: _____ S/N _____ Device: _____

Sensitivity: Most More Normal Less Least

Verification: None 12 s 24 s 36 s 60 s

Pre-Alarm: None 20% 40% 60% 80%

Base type: Standard Relay Isolator

Message: 1) _____ 2) _____

Model: _____ S/N _____ Device: _____

Sensitivity: Most More Normal Less Least

Verification: None 12 s 24 s 36 s 60 s

Pre-Alarm: None 20% 40% 60% 80%

Base type: Standard Relay Isolator

Message: 1) _____ 2) _____

Model: _____ S/N _____ Device: _____

Sensitivity: Most More Normal Less Least

Verification: None 12 s 24 s 36 s 60 s

Pre-Alarm: None 20% 40% 60% 80%

Base type: Standard Relay Isolator

Message: 1) _____ 2) _____

Figure 4-4: Signature Detector Programming Worksheet

Programming instructions

Job Name: _____

Page ____ **of** ____

Panel: _____ **Card:** _____

Model: _____ **S/N** _____ **Device: 1st)** _____ **2nd)** _____

Device #1	Device #2
Device Type: _____	Device Type: _____
Personality: _____	Personality: _____
Message: 1) _____	Message: 1) _____
2) _____	2) _____

Model: _____ **S/N** _____ **Device: 1st)** _____ **2nd)** _____

Device #1	Device #2
Device Type: _____	Device Type: _____
Personality: _____	Personality: _____
Message: 1) _____	Message: 1) _____
2) _____	2) _____

Model: _____ **S/N** _____ **Device: 1st)** _____ **2nd)** _____

Device #1	Device #2
Device Type: _____	Device Type: _____
Personality: _____	Personality: _____
Message: 1) _____	Message: 1) _____
2) _____	2) _____

Model: _____ **S/N** _____ **Device: 1st)** _____ **2nd)** _____

Device #1	Device #2
Device Type: _____	Device Type: _____
Personality: _____	Personality: _____
Message: 1) _____	Message: 1) _____
2) _____	2) _____

Figure 4-5: Signature Module Programming Worksheet

Job Name: _____

Page ____ of ____

Panel: _____ Output Group: _____

Response: __ __ __ Type: Active Trouble

- Relay Device: __ __ __ __ __ On 20 bpm 120 bpm Temporal
- Delay Delay Type: Act and Restoration Activation Restoration Time: __ __ __ __ s
- Dialer Account No.: __ __ __ __ Send On: Activation Restoration
Priority: Life Safety Property System Integrity
String: (CID) __ __ __ __ __ __ __ __ __ __ (4/2) __ __

Response: __ __ __ Type: Active Trouble

- Relay Device: __ __ __ __ __ On 20 bpm 120 bpm Temporal
- Delay Delay Type: Act and Restoration Activation Restoration Time: __ __ __ __ s
- Dialer Account No.: __ __ __ __ Send On: Activation Restoration
Priority: Life Safety Property System Integrity
String: (CID) __ __ __ __ __ __ __ __ __ __ (4/2) __ __

Response: __ __ __ Type: Active Trouble

- Relay Device: __ __ __ __ __ On 20 bpm 120 bpm Temporal
- Delay Delay Type: Act and Restoration Activation Restoration Time: __ __ __ __ s
- Dialer Account No.: __ __ __ __ Send On: Activation Restoration
Priority: Life Safety Property System Integrity
String: (CID) __ __ __ __ __ __ __ __ __ __ (4/2) __ __

Response: __ __ __ Type: Active Trouble

- Relay Device: __ __ __ __ __ On 20 bpm 120 bpm Temporal
- Delay Delay Type: Act and Restoration Activation Restoration Time: __ __ __ __ s
- Dialer Account No.: __ __ __ __ Send On: Activation Restoration
Priority: Life Safety Property System Integrity
String: (CID) __ __ __ __ __ __ __ __ __ __ (4/2) __ __

Figure 4-6: Output Group Programming Worksheet

Programming instructions

Job Name: _____

Page ____ of ____

Panel: _____ Zone: _____

Zone Type: Alarm Supervisory Monitor

Zone Code: _ _ _ _

Message: 1) _____

2) _____

Zone Members (32 max):

_____	_____	_____	_____
_____	_____	_____	_____
_____	_____	_____	_____
_____	_____	_____	_____
_____	_____	_____	_____
_____	_____	_____	_____
_____	_____	_____	_____
_____	_____	_____	_____
_____	_____	_____	_____

Output groups (6 max):

_____	_____	_____
_____	_____	_____

Figure 4-7: Zone Programming Worksheet

Summary

This chapter provides simplified wiring schematics for standard applications.

Content

Notification appliance circuits • 5.2

Initiating device circuits • 5.4

Coded alarm signaling • 5.6

Remote station protective signaling system • 5.8

Auxiliary protective signaling • 5.10

Notification appliance circuits

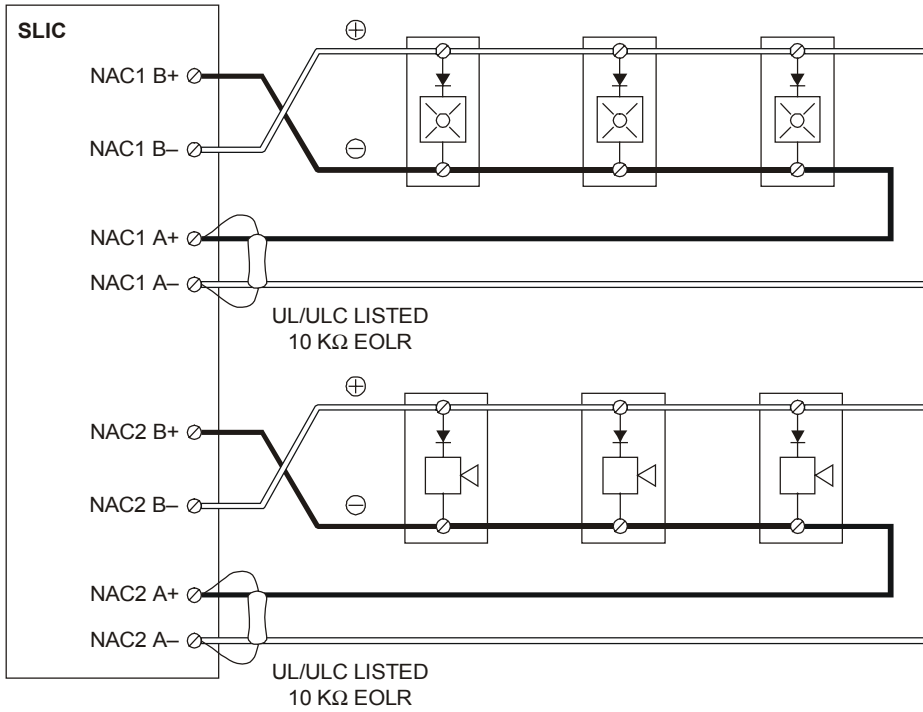

Note: The plus and minus symbols indicate signal polarity when the NAC circuit is turned on.

Typical Class A NAC circuits

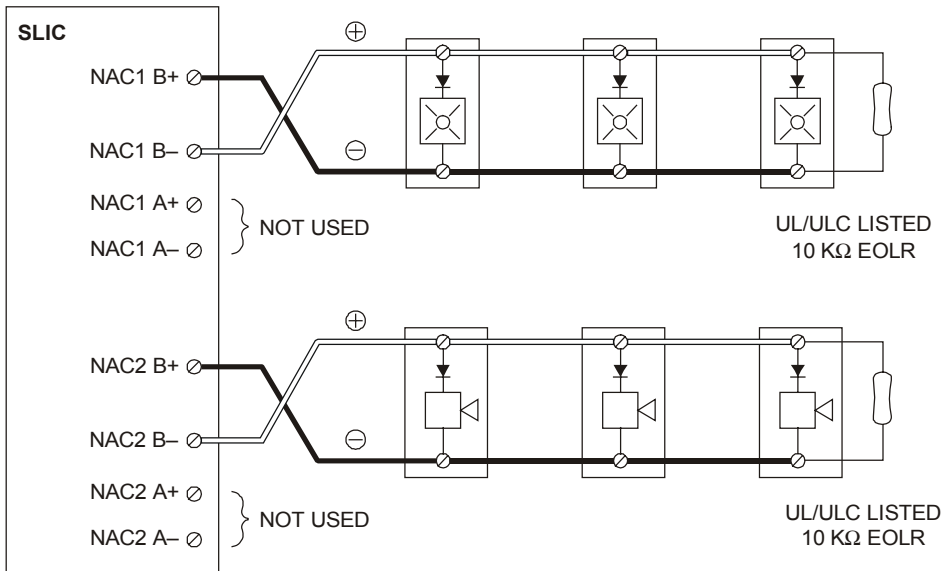

Note: The plus and minus symbols indicate signal polarity when the NAC circuit is turned on.

Typical Class B NAC circuits

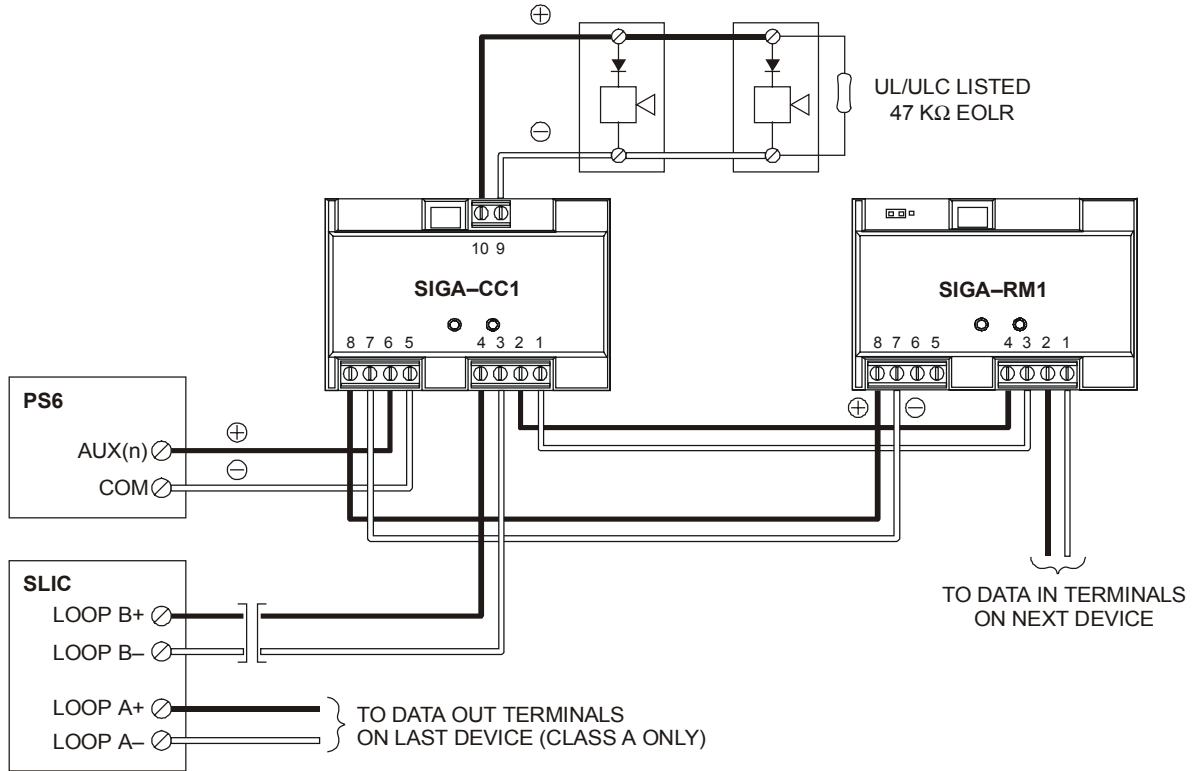

Note: The plus and minus symbols indicate signal polarity when the NAC circuit is turned on.

Typical NAC riser wiring

Initiating device circuits

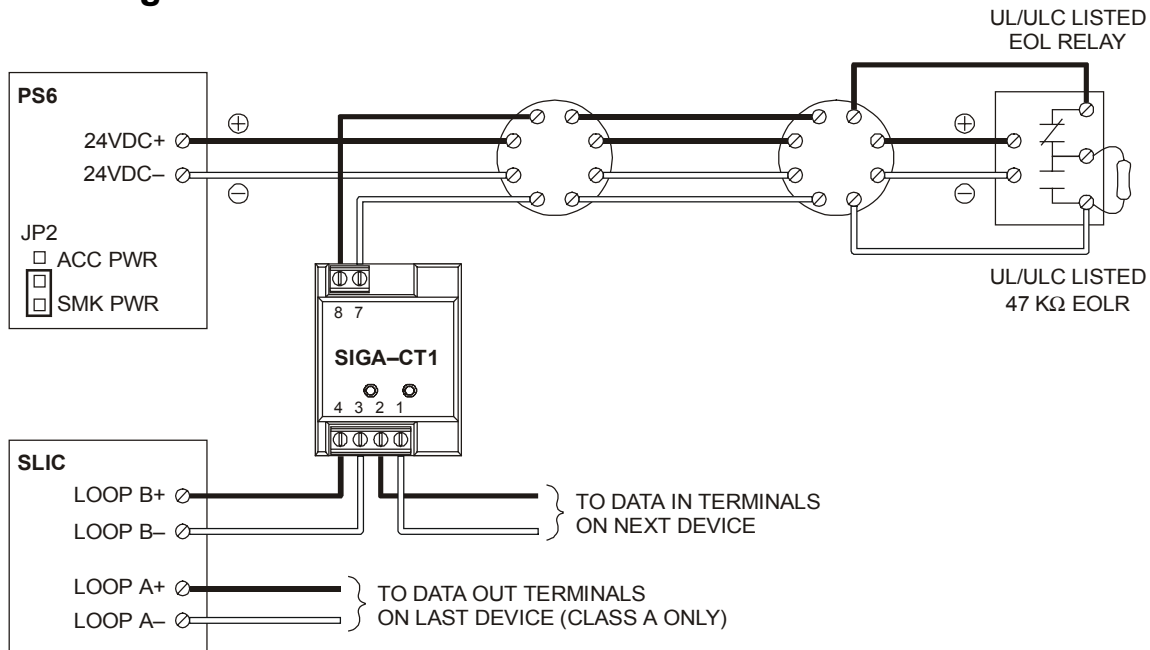

Typical four-wire smoke detector circuit

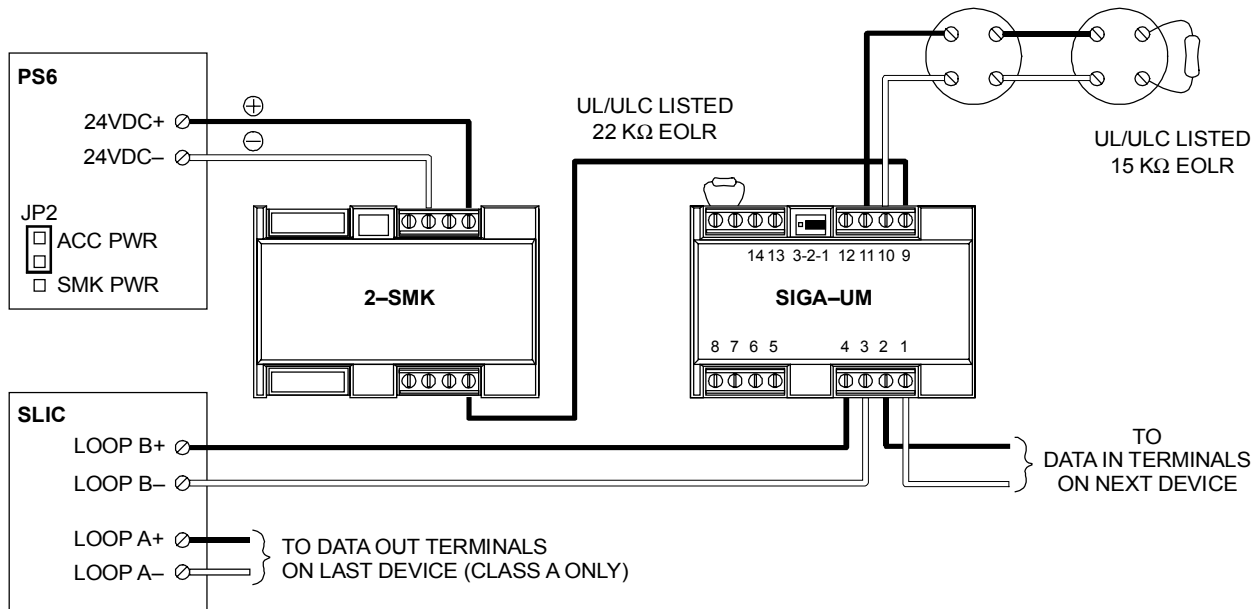

Typical Class B two-wire smoke detector circuit

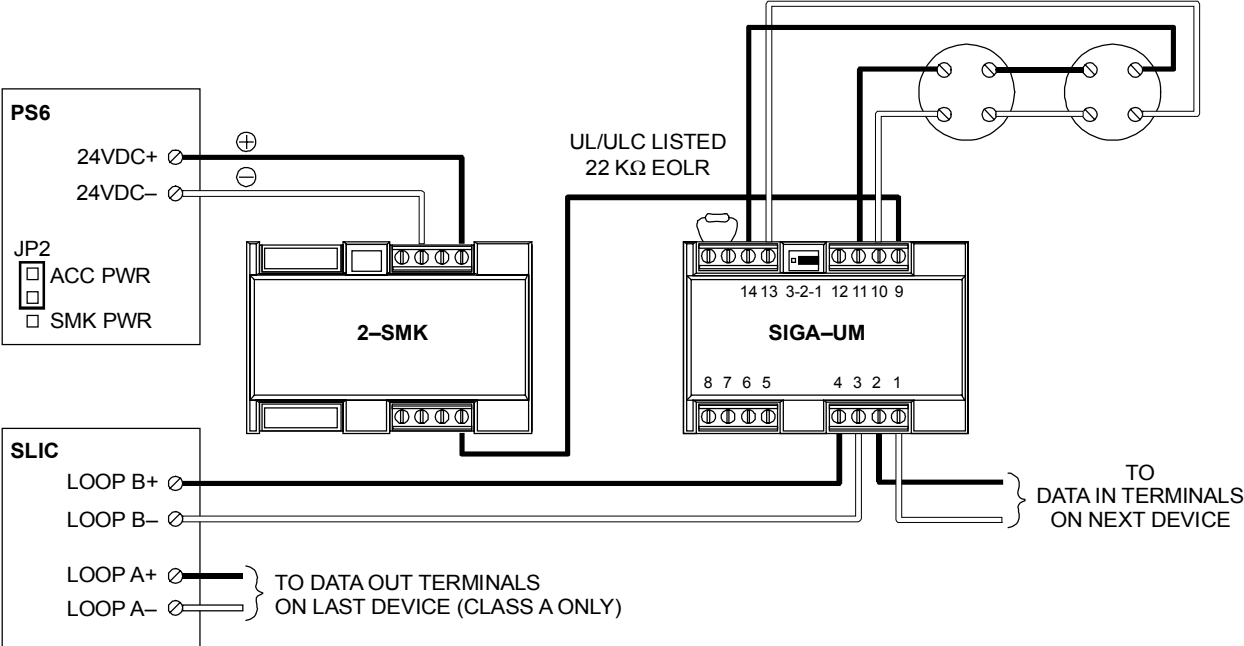

Typical Class A two-wire smoke detector circuit

Coded alarm signaling

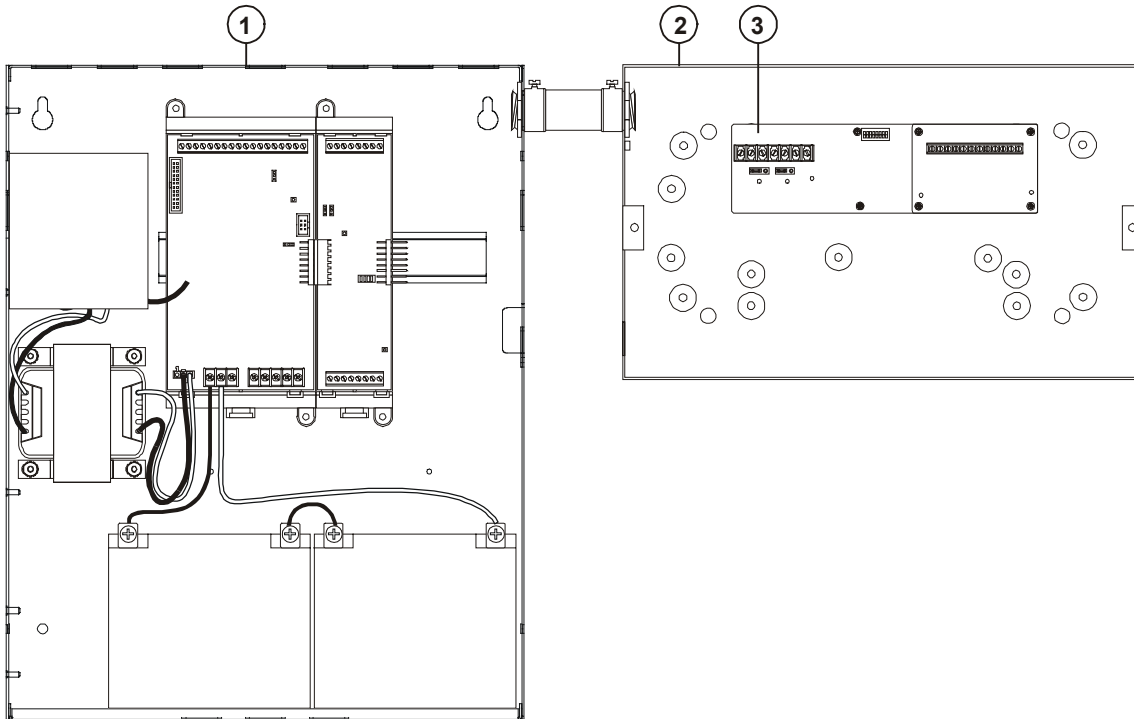

1. FACP: Fire alarm control panel with a CPU, PS6, and standby batteries.

2. MFC-A Accessory Enclosure: Used for mounting the remote fire alarm equipment.

3. CDR-3 Bell Coder: Provides coded alarm signals for 24 Vdc notification appliance circuits and one of three evacuation signals (temporal, 60 bpm, and 90 bpm).

Note: CDR-3 must have firmware version greater than 2.0.

Notes

- Place the MFC-A and the FACP in the same room and connect using a section of conduit no greater than 20 ft in length. Run all wiring between cabinets through the conduit.
- Set SW-6 on CDR-3 to ON. Refer to the CDR-3 installation sheet for programming information.
- Install a 10 k Ω EOLR across TB2-1 and TB2-2, and TB2-11 and TB2-12 on the CDR-3.
- Set JP2 on the PS6 for ACC PWR
- If the system uses a NAC circuit on an SLIC to output the coded signal, program the NAC circuit signal rate as Steady.
- If the system uses the NAC 1 circuit on an SLIC to output the coded signal to audible notification appliances, set JP1 and JP2 on the SLIC to EXT.

Figure 5-1: Typical equipment layout, coded alarm signaling application

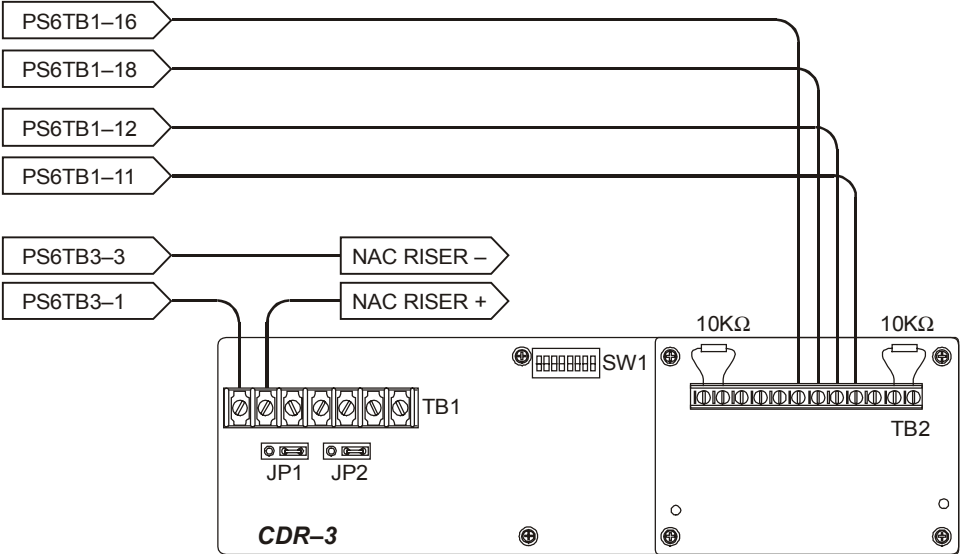

Figure 5-2: Coded alarm signaling wiring (coded alarm signal only)

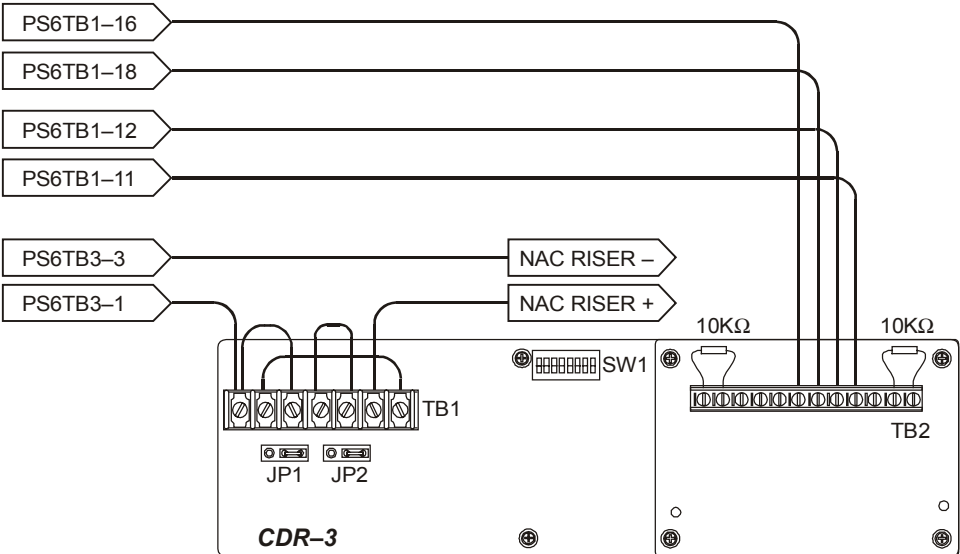
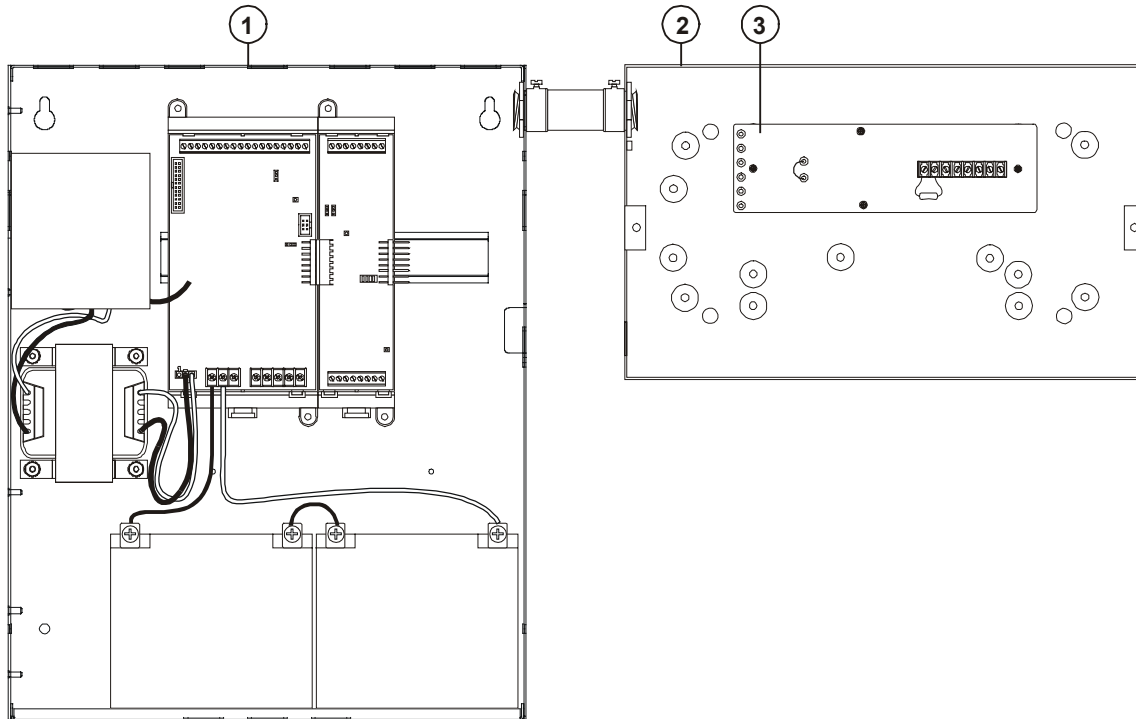

Figure 5-3: Coded alarm signaling wiring (coded signal followed by evacuation signal)

Remote station protective signaling system



1. FACP: Fire alarm control panel with a CPU, PS6, ZB16-4, and standby batteries.

2. MFC-A Accessory Enclosure: Used for mounting the remote fire alarm equipment.

3. RPM Reverse Polarity Module: Provides three independent reverse polarity signals (alarm, supervisory, trouble) for transmitting system status to a remote location.

Notes

- Place the MFC-A and the FACP in the same room and connect using a section of conduit no greater than 20 ft in length. Run all wiring between cabinets through the conduit.
- Set JP2 on the PS6 for ACC PWR.
- Install a 3.9 K Ω EOLR across TB1-1 and TB1-2 on the RPM.

Figure 5-4: Typical equipment layout, Remote station protective signaling application

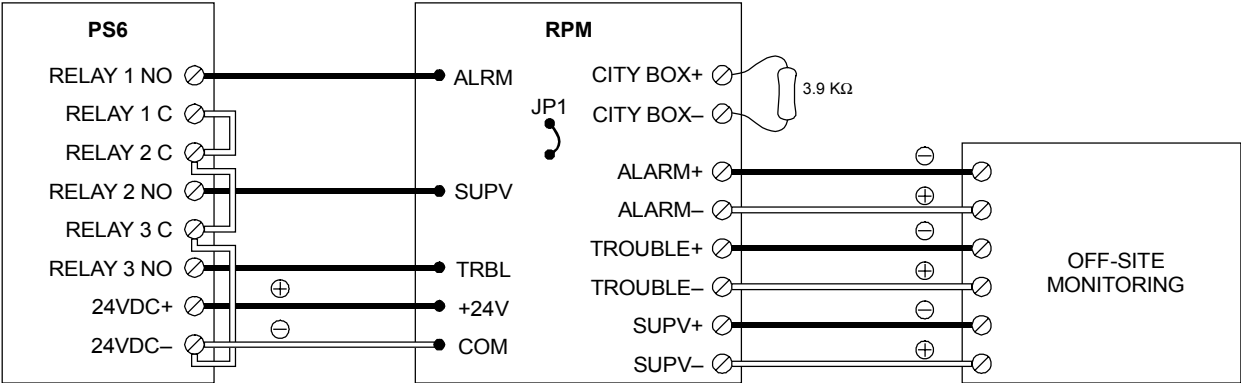

Note: Plus and minus symbols indicate signal polarity when the circuit is active.

Figure 5-5: Remote station protective signaling wiring

Auxiliary protective signaling

Wire as shown in Figure 5-6. Program the SIGA-CC1 as a common alarm output device. Plus and minus symbols indicate signal polarity with the circuit turned on.

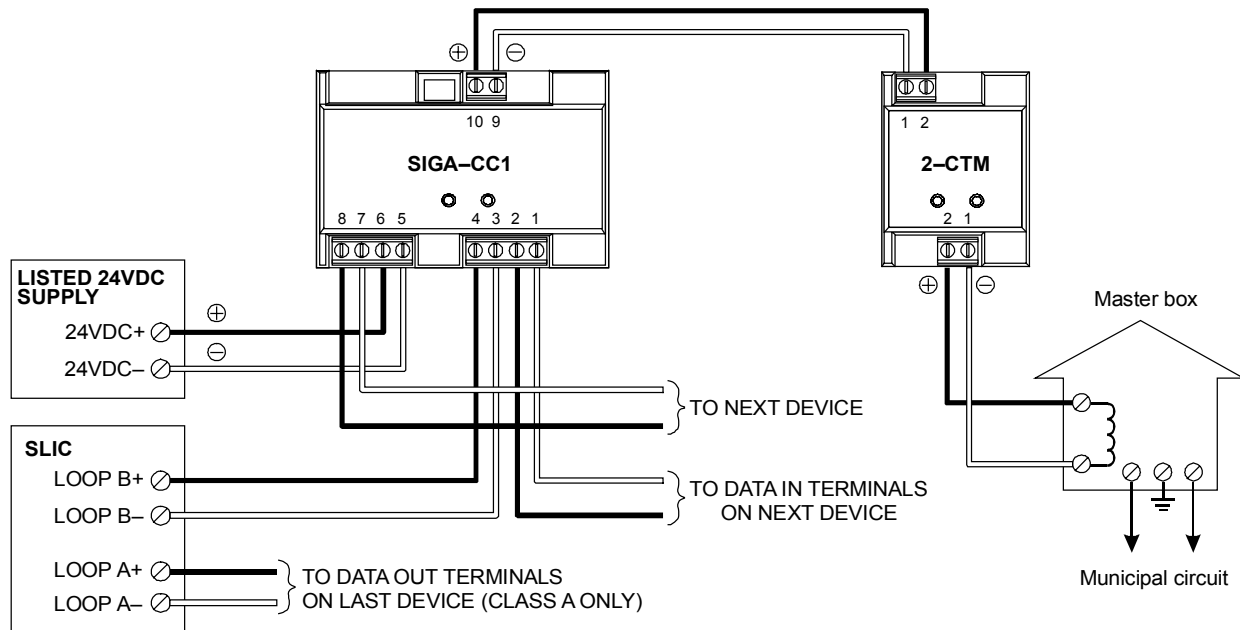

Figure 5-6: Auxiliary protective signaling cabling diagram

Summary

This chapter provides instructions for maintaining the system.

Content

- Pseudo point definitions • 6.2
 - Table 6-1: Main Panel pseudo points • 6.2
 - Table 6-2: Remote Annunciator pseudo points • 6.2
 - Table 6-3: Power Supply pseudo points • 6.3
 - Table 6-4: SLIC card pseudo points • 6.3
 - Table 6-5: Dialer pseudo points • 6.4
 - Table 6-6: General CPU pseudo points • 6.5
- Maintenance tasks • 6.6

Pseudo point definitions

Table 6-1: Main Panel pseudo points

LCD Indication	Event Type	Definition
Panel xx Card Communications	Trouble	CPU has failed to communicate with the option card at address xx.
Panel 01 Reset Extension	Monitor/Trouble	Signature loop is still resetting.
Panel 01 Service Active Trouble	Trouble	Service group was restored with a device still in the active condition.
Pnl 0x Database Incompatible	Trouble	Changes made to the system programming on the control panel were not updated in this unit.
Panel 01 Reboot Fault		Control panel CPU restarted unexpectedly.
Panel 0x, CH1 Communications	Trouble	Annunciator is not communicating on RS485 channel 1.
Panel 01 Task Failure	Trouble	Internal processing fault.
Card xx Setup Mismatch	Trouble	CPU encountered problem configuring the option card at address xx.
Dailer Setup Mismatch	Trouble	A problem has occurred with the CPU configuring the dialer card.
Power Supply Setup Mismatch	Trouble	A problem has occurred with the CPU configuring the POWER supply card.
Panel 01 LED/Switch display	Trouble	LED/Switch card is not connected.
Panel 0x, CH2 Communications	Trouble	Annunciator is not communicating on RS485 channel 2.
Pnl 01 Database Supervision	Trouble	Internal CPU memory failure
Panel 01 Code Supervision	Trouble	Internal CPU memory failure
Panel 01, Call For Service	Trouble	Internal CPU processing error
Panel 01, ROM Supervision	Trouble	Internal CPU memory failure
Panel 01 RS232 Port Fault	Trouble	
Panel 01 Unexpected Card	Trouble	CPU detected an option card not defined in the database.
Panel 01 Switch Latched	Trouble	Button either on the main display or on an LED/Switch card has been pressed too long.
Panel 01 Loop Database Fault	Trouble	Internal CPU memory failure with Signature data.

Table 6-2: Remote Annunciator pseudo points

LCD Indication	Event Type	Definition
Ann 0x Service Active Trouble	Trouble	Indicates that a device was left in an active condition after service group has restored.
Ann 0x Database Incompatible	Trouble	Indicates that the data
Annunciator 0x Reboot Fault	Trouble	Indicates CPU has restarted due to internal processing failure.

LCD Indication	Event Type	Definition
Ann 0x, CH1 Communications	Trouble	Indicates failure to communicate with the main panel on RS485 channel 1.
Annunciator 0x Task Failure	Trouble	Internal software failure
Ann 0x, LED/ Switch Display	Trouble	Indicates that a SL30-x has been disconnected or is connected but not defined.
Ann 0x, CH2 Communications	Trouble	Indicates failure to communicate with the main panel on RS485 channel 2.
Ann 0x Database Supervision	Trouble	Internal memory failure
Ann 0x Code Supervision	Trouble	Internal memory failure
Ann 0x, Call For Service	Trouble	Internal software failure
Ann 0x ROM Supervision	Trouble	Internal memory failure
Ann 0x RS232 Port Fault	Trouble	
Ann 0x Program Mode	Trouble	Panel has entered program mode.
Ann 0x Switch Latched	Trouble	Indicates that a button either on the main display or on an SL30-x has been pressed to long.
Annunciator 0x Power Fault	Trouble	Indicates a loss of power on either of the 24vdc inputs to the RAI card.

Table 6-3: Power Supply pseudo points

LCD Indication	Event Type	Definition
Battery Charger Fault	Trouble	This fault will occur when the battery charger charging voltage falls below 20.4vdc.
Battery Wiring or Battery Fault	Trouble	Caused by an open in the battery wiring or if the batteries are below 20.4vdc.
Aux Power 1/2 Shorted	Trouble	This point occurs when Aux 1 or Aux 2 power is shorted on the PS6
Aux Power 3 Shorted	Trouble	This point occurs when Aux 3
Smoke Power Shorted	Trouble	This point occurs when smoke power is shorted
Primary AC Power Failure	Trouble	Caused by loss of AC or very low AC.
Excessive Battery Current	Trouble	Will go active when PS6 detects over current condition
Check System Wiring	Trouble	Indicates a ground fault exists on field wiring.
Power Supply Card RAM Fault	Trouble	Internal memory fault
Power Supply Card ROM Fault	Trouble	Internal memory fault
Power Supply EEPROM Fault	Trouble	Internal memory fault

Table 6-4: SLIC card pseudo points

LCD Indication	Event Type	Definition
Card 0x, Loop Wiring Problem	Trouble	Indicates a break on a Class A signature loop
Card 0x Map Fault	Trouble	Signature map is different than the one written in memory

LCD Indication	Event Type	Definition
Card 0x, Mapping In Progress	Monitor	Indicates Signature devices are in the process of being mapped.
Card 0x Unconfig. Device	Trouble	Indicates that a new signature device has been detected on a loop.
Card 0x, Line Initialization	Monitor	Occurs after power up or a restart. Indicates signature devices are being initialized.
Card 0x, Loop Ground Fault	Trouble	Indicates a ground fault on a signature module.
Card 0x, LIM Driver Fault	Trouble	Internal hardware failure.
Card 0x, RAM Supervision	Trouble	Internal memory fault
Card 0x, ROM Supervision	Trouble	Internal memory fault
Card 0x, EEPROM Supervision	Trouble	Internal memory fault

Table 6-5: Dialer pseudo points

LCD Indication	Event Type	Definition
Primary Phone Line:check Telco	Trouble	Telephone line has low or no voltage
Secondary Phone Line:check Telco	Trouble	Telephone line has low or no voltage
Pri. Receiver Failed to answer	Trouble	Dialer attempted to dial event to CMS but did not get an answer.
Sec. Receiver Failed to answer	Trouble	Dialer attempted to dial event to CMS but did not get an answer.
Dialer Account 1 Fault	Trouble	Indicates dialer did not get proper handshake for event sent to the CMS for Account 1.
Dialer Account 2 Fault	Trouble	Indicates dialer did not get proper handshake for event sent to the CMS for Account 2.
Dialer Account 3 Fault	Trouble	Indicates dialer did not get proper handshake for event sent to the CMS for Account 3.
Dialer Account 4 Fault	Trouble	Indicates dialer did not get proper handshake for event sent to the CMS for Account 4.
Dialer Account 5 Fault	Trouble	Indicates dialer did not get proper handshake for event sent to the CMS for Account 5.
Dialer Account 6 Fault	Trouble	Indicates dialer did not get proper handshake for event sent to the CMS for Account 6.
Dialer Account 7 Fault	Trouble	Indicates dialer did not get proper handshake for event sent to the CMS for Account 7.
Dialer Account 8 Fault	Trouble	Indicates dialer did not get proper handshake for event sent to the CMS for Account 8.
Dialer ROM Fault	Trouble	Internal memory fault
Dialer Queue Overflow	Trouble	Indicates that too many dialer messages are trying to be sent.
Dialer Card, RAM Supervision	Trouble	Internal memory fault

Table 6-6: General CPU pseudo points

LCD Indication	Event Type	Definition
Startup Response	Monitor	Monitor point that goes active on system startup or after restart.
First Alarm	Alarm	Occurs anytime that the system goes into alarm for the first time.
First Supervisory	Supervisory	Occurs anytime that the system goes into supervisory for the first time.
First Trouble	Trouble	Occurs anytime that the system goes into a trouble for the first time.
First Monitor	Monitor	Occurs anytime that the system goes into a monitor condition for the first time.
Evacuation		
Drill	Monitor	This point will go active anytime drill is pressed.
Alarm Silence	Monitor	This point will go active anytime alarm silence is pressed.
Two Stage Expiration		
Reset	Monitor	This point goes active anytime reset is pressed.
Reset Phase 1	Monitor	Active during the power down phase of reset.
Reset Phase 2	Monitor	Active during the retard phase of reset.
Reset Phase 3	Monitor	Active during the restoration phase of reset.
First Disable	Trouble	Activated the first time an item is disabled from the front menu.
First Test	Trouble	Activated the first time a service group is started from the front menus.
Two Stage Timer Started		
User Trouble	Trouble	Triggered by custom programming.

Maintenance tasks

What is it you want to do	This is how you do it
Change the fuse	<ol style="list-style-type: none">1. Switch the circuit breaker that supplies ac power to the control panel to the OFF position.2. Expose the ac terminal block and pull out the fuse holder.3. Replace the blown fuse with a new one of the same type and size.4. Plug the fuse holder back into the ac terminal block.5. Switch the circuit breaker that supplies ac power to the control panel to the ON position.
Replacing a SIGA device when mapping is disabled)	<hr/> <p>WARNING: Replacing a device when mapping is disabled leaves the area unprotected. The control panel does not automatically reassign responses to replaced devices when mapping is disabled.</p> <hr/> <p>To replace devices on a loop that operates with mapping disabled, you must first enable mapping then accept the map. After you replace your devices, you can disable mapping on the loop.</p> <p>Note: Replacement devices must be the same model as the devices being replaced.</p> <ol style="list-style-type: none">1. Press Menu.2. Log onto the panel as a Level 4 operator.3. Choose Enable > Loop Mapping.4. Enter the card number of the SLIC that connects to the device you want to replace. Wait until mapping finishes before continuing.5. Choose Cards > Edit.6. Enter the card number of the SLIC that connects to the device you want to replace.7. Choose Accept Map. If actual and expected data for detectors and modules are the same, press Enter.8. Choose Exit > Exit > Save and Sync.9. Replace the device.

Summary

This appendix provides worksheets for calculating maximum wire lengths for notification and Signature circuits, and for sizing standby batteries.

Content

Notification appliance circuit maximum wire length calculation • A.2

Signature loop maximum wire length calculations • A.3

Battery calculation • A.8

Notification appliance circuit maximum wire length calculation

Use this worksheet to determine the maximum wire length of a notification appliance circuit. Fill in one worksheet for each NAC circuit connected to the panel.

Maximum signal loss allowed ¹		1.5		V
	×	1000	—	
		1500		
Wire resistance per 1000 ft/pair ²	÷			Ω
Total operating current required ³	÷			A
Maximum wire length				ft

Notes

1. For worst case estimates, allow a 1.5-volt signal loss due to line impedance and that all appliances are clustered at the end of the circuit.
2. Use 3.5 for 12 AWG and 2.5 mm² wire, 5.2 for 14 AWG and 1.5 mm² wire, 8.0 for 16 AWG and 1.0 mm² wire, and 13.0 for 18 AWG and 0.75 mm² wire.
3. Use the filtered 20 Vdc Average Operating Current ratings found on the installation or catalog sheet of each device.

Signature loop maximum wire length calculations

Use this worksheet to determine the maximum amount of wire you can use to construct a Signature loop.

Step 1: Calculate the total amount of wire you can use based on the cable manufacturer's capacitance per foot rating. Total amount of wire shall not exceed the values listed in Table A-1.

$$\begin{array}{r} \text{Cable capacitance} \\ \div \frac{500000}{\boxed{}} \text{ pF/ft} \\ \hline \text{Total wire} \\ \boxed{} \text{ ft} \end{array}$$

Table A-1: Maximum amount of wire you can use to construct a Signature loop

Wire type	14 AWG / 1.5 mm ²	16 AWG / 1.0 mm ²	18 AWG / 0.75 mm ²
Twisted pair, nonshielded 25 pF/36 pF/38 pF	13157 ft (4010 m)	13888 ft (4233 m)	20000 ft (6096 m)
Twisted pair, shielded 58 pF/82 pF/84 pF	5952 ft (1814 m)	6098 ft (1859 m)	8621 ft (2628 m)
Nontwisted pair, nonshielded 20 pF/20 pF/20 pF	20000 ft (6096 m)	20000 ft (6096 m)	20000 ft (6096 m)

Step 2: Use Table A-2, Table A-3, Table A-4, and Table A-5 to determine the longest allowable circuit path based on wire size and type, and the number of detector, module, SIGA-UMs or -MABs installed on the loop.

In the illustration below, the longest circuit path (shown in bold lines) is 1240 ft (377.95 m). The total amount of wire comprising the loop is 1740 ft (530.35 m).

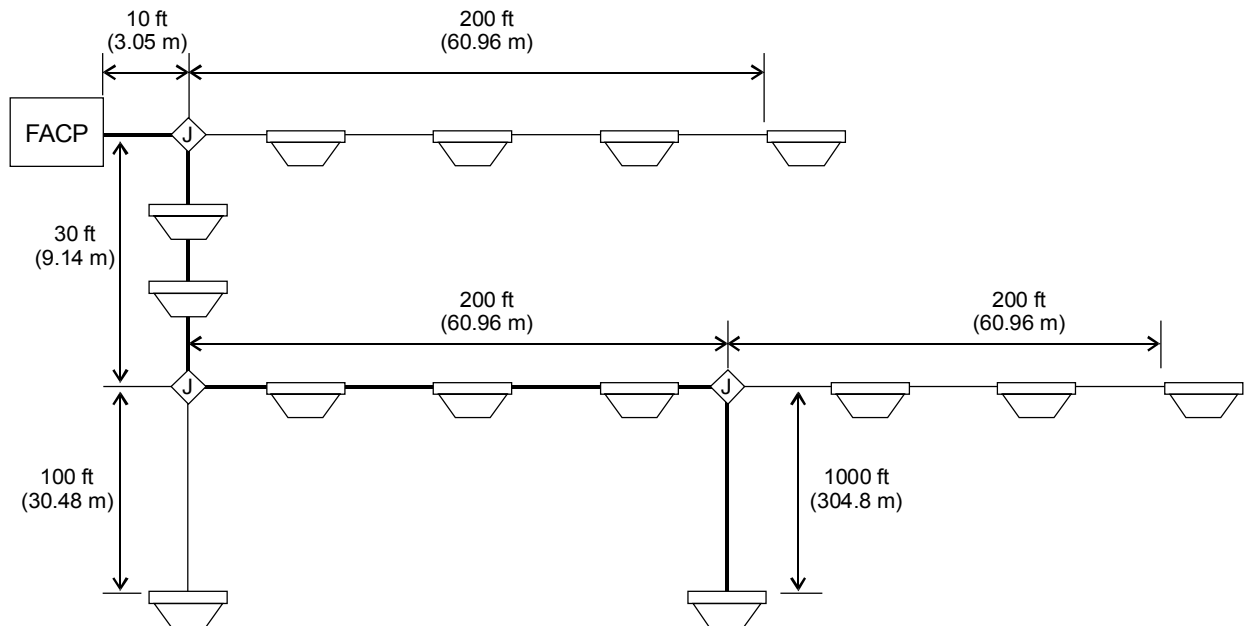

Table A-2: Longest allowable circuit path with 0 SIGA-UMs or SIGA-MABs configured for 2-wire smokes

Signature detector addresses	Signature module addresses	Maximum allowable wire distance using nontwisted, nonshielded wire pairs					
		18 AWG		16 AWG		14 AWG	
		ft	m	ft	m	ft	m
1-25	0	7437	2267	11815	3601	18792	5728
26-50	0	7038	2145	11180	3408	17782	5420
51-75	0	6638	2023	10545	3214	16772	5112
76-100	0	6238	1901	9910	3021	15762	4804
101-125	0	5839	1780	9275	2827	14752	4497
0	1-25	7267	2215	11544	3519	18361	5597
1-25	1-25	6867	2093	10909	3325	17351	5289
26-50	1-25	6467	1971	10275	3132	16342	4981
51-75	1-25	6068	1849	9640	2938	15332	4673
76-100	1-25	5668	1728	9005	2745	14322	4365
101-125	1-25	5268	1606	8370	2551	13312	4057
0	26-50	6697	2041	10639	3243	16921	5157
1-25	26-50	6297	1919	10004	3049	15911	4850
26-50	26-50	5897	1798	9369	2856	14901	4542
51-75	26-50	5498	1676	8734	2662	13891	4234
76-100	26-50	5098	1554	8099	2469	12881	3926
101-125	26-50	4698	1432	7464	2275	11871	3618
0	51-75	5906	1800	9383	2860	14923	4549
1-25	51-75	5250	1600	8340	2542	13265	4043
26-50	51-75	4633	1412	7360	2243	11707	3568
51-75	51-75	4051	1235	6435	1961	10235	3120
76-100	51-75	3498	1066	5558	1694	8839	2694
101-125	51-75	2973	906	4723	1440	7512	2290
0	76-100	3931	1198	6245	1903	9932	3027
1-25	76-100	3404	1037	5407	1648	8601	2621
26-50	76-100	2899	883	4605	1404	7324	2232
51-75	76-100	2413	735	3833	1168	6096	1858
76-100	76-100	1945	593	3089	942	4913	1498
101-125	76-100	1493	455	2371	723	3771	1149
0	101-125	2631	802	4180	1274	6649	2027
1-25	101-125	2165	660	3439	1048	5470	1667
26-50	101-125	1713	522	2721	829	4328	1319
51-75	101-125	1274	388	2023	617	3218	981
76-100	101-125	847	258	1345	410	2140	652
101-125	101-125	431	131	685	209	1089	332

Table A-3: Longest allowable circuit path with 1–5 SIGA-UMs or SIGA-MABs configured for 2-wire smokes

Signature detector addresses	Signature module addresses	Maximum wire distance using nontwisted, nonshielded wire pairs					
		18 AWG		16 AWG		14 AWG	
		ft	m	ft	m	ft	m
1–25	0	6778	2066	10768	3282	17126	5220
26–50	0	6131	1869	9741	2969	15492	4722
51–75	0	5501	1677	8739	2664	13899	4236
76–100	0	4885	1489	7760	2365	12342	3762
101–125	0	4282	1305	6802	2073	10819	3298
0	1–25	5353	1632	8504	2592	13525	4122
1–25	1–25	4720	1439	7498	2286	11926	3635
26–50	1–25	4100	1250	6513	1985	10359	3157
51–75	1–25	3491	1064	5546	1691	8821	2689
76–100	1–25	2893	882	4597	1401	7311	2228
101–125	1–25	2306	703	3663	1116	5826	1776
0	26–50	3776	1151	5999	1829	9542	2908
1–25	26–50	3153	961	5009	1527	7966	2428
26–50	26–50	2539	774	4034	1230	6416	1956
51–75	26–50	1935	590	3075	937	4890	1491
76–100	26–50	1340	409	2130	649	3387	1032
101–125	26–50	754	230	1197	365	1905	581
0	51–75	2491	759	3957	1206	6293	1918
1–25	51–75	1868	569	2967	904	4720	1439
26–50	51–75	1254	382	1992	607	3168	966
51–75	51–75	648	198	1030	314	1638	499
76–100	51–75	50	15	80	24	126	39
101–125	51–75						
0	76–100	1386	422	2201	671	3501	1067
1–25	76–100	760	232	1208	368	1921	586
26–50	76–100	143	44	227	69	361	110
51–75	76–100						
76–100	76–100						
101–125	76–100						
0	101–125						
1–25	101–125						
26–50	101–125						
51–75	101–125						
76–100	101–125						
101–125	101–125						

Table A-4: Longest allowable circuit path with 6–10 SIGA-UMs or SIGA-MABs configured for 2-wire smokes

Signature detector addresses	Signature module addresses	Maximum wire distance using nontwisted, nonshielded wire pairs					
		18 AWG		16 AWG		14 AWG	
		ft	m	ft	m	ft	m
1–25	0	5045	1538	8015	2443	12748	3886
26–50	0	4494	1370	7139	2176	11355	3461
51–75	0	3950	1204	6275	1913	9981	3042
76–100	0	3414	1040	5423	1653	8625	2629
101–125	0	2884	879	4581	1396	7286	2221
0	1–25	4106	1252	6523	1988	10375	3162
1–25	1–25	3542	1080	5627	1715	8950	2728
26–50	1–25	2985	910	4742	1445	7542	2299
51–75	1–25	2435	742	3868	1179	6152	1875
76–100	1–25	1891	576	3004	916	4778	1456
101–125	1–25	1353	412	2150	655	3419	1042
0	26–50	2869	874	4557	1389	7248	2209
1–25	26–50	2296	700	3648	1112	5802	1768
26–50	26–50	1730	527	2749	838	4372	1332
51–75	26–50	1170	357	1859	567	2957	901
76–100	26–50	617	188	979	299	1558	475
101–125	26–50	68	21	108	33	172	53
0	51–75	1796	547	2853	869	4537	1383
1–25	51–75	1214	370	1929	588	3067	935
26–50	51–75	638	195	1014	309	1613	492
51–75	51–75	69	21	109	33	173	53
76–100	51–75	N/A					
101–125	51–75	N/A					
0	76–100	833	254	1323	403	2105	642
1–25	76–100	242	74	385	117	613	187
26–50	76–100	N/A					
51–75	76–100	N/A					
76–100	76–100	N/A					
101–125	76–100	N/A					
0	101–125	N/A					
1–25	101–125	N/A					
26–50	101–125	N/A					
51–75	101–125	N/A					
76–100	101–125	N/A					
101–125	101–125	N/A					

Table A-5: Longest allowable circuit path with 11–15 SIGA-UMs or SIGA-MABs configured for 2-wire smokes

Signature detector addresses	Signature module addresses	Maximum wire distance using nontwisted, nonshielded wire pairs					
		18 AWG		16 AWG		14 AWG	
		ft	m	ft	m	ft	m
1–25	0	3931	1198	6245	1903	9932	3027
26–50	0	3427	1045	5444	1659	8659	2639
51–75	0	2928	892	4651	1418	7397	2255
76–100	0	2432	741	3864	1178	6145	1873
101–125	0	1941	592	3083	940	4903	1495
0	1–25	3247	990	5158	1572	8204	2501
1–25	1–25	2722	830	4324	1318	6878	2096
26–50	1–25	2202	671	3498	1066	5563	1696
51–75	1–25	1686	514	2678	816	4259	1298
76–100	1–25	1174	358	1865	568	2966	904
101–125	1–25	666	203	1058	323	1683	513
0	26–50	2204	672	3502	1067	5570	1698
1–25	26–50	1664	507	2644	806	4205	1282
26–50	26–50	1129	344	1793	547	2852	869
51–75	26–50	598	182	950	289	1511	460
76–100	26–50	71	22	113	34	179	55
101–125	26–50						
0	51–75	1263	385	2007	612	3192	973
1–25	51–75	710	216	1128	344	1794	547
26–50	51–75	161	49	256	78	407	124
51–75	51–75						
76–100	51–75						
101–125	51–75						
0	76–100						
1–25	76–100						
26–50	76–100						
51–75	76–100						
76–100	76–100						
101–125	76–100						
0	101–125						
1–25	101–125						
26–50	101–125						
51–75	101–125						
76–100	101–125						
101–125	101–125						

Battery calculation worksheet

Use this worksheet to determine the size of standby battery required for the panel to operate without ac power. Obtain the current ratings for each device installed in the system from their respective installation sheets.

Example: There are 10 horns connected to NAC2. Each horn has an average operating current of 80 mA. Enter 800 mA in the Alarm box for NAC 2.

	Standby (mA)	Alarm (mA)	
Base panel ^{[1][5]}	249	324	
Extra card ^[4]			
SL30			
NAC 1 current load			
NAC 2 current load			
AUX 1 current load			
AUX 2 current load			
AUX 3 current load			
SMK/ACC power (Form A)			
Total Current Required ^[2]			
	× <input type="text"/> hr	× <input type="text"/> min	
		÷ 60	
	+		= <input type="text"/> mAh
			× 1.2
			<input type="text"/> mAh
			÷ 1000
			Battery size ^[3] = <input type="text"/> Ah

Notes

- [1] Base panel current includes the PS6, the CPU/Display, and a fully-loaded SLIC.
- [2] If the Total Current Required value exceeds 6 A, switch part of the load to an auxiliary power source. The auxiliary power source must be UL/ULC listed for Fire Protective Signaling Systems.
- [3] If the calculated battery size exceeds 40 Ah, switch part of the load to an auxiliary power source.
- [4] If a DLD is installed, enter 13 mA for Standby Current and 20 mA for Alarm Current.
If a ZR8 is installed, enter 11 mA for Standby Current and 18 mA for Alarm Current plus 18 mA for each energized relay.
If a RS485 card is installed, enter 60 mA for Standby Current and 60 mA for Alarm Current.
- [5] If an SL30 is installed, enter 1 mA for Standby Current and 20 mA for Alarm Current and 0.75 mA for each energized LED.

(A) Smoke/Accessory (SMK/ACC) Power current load calculation (max 250 mA)

Card	Qty	Standby Current (mA)	Qty x Standby Current (mA)	Alarm Current (mA)	Qty x Alarm Current (mA)
CDR-3	<input type="text"/>	60	<input type="text"/>	100	<input type="text"/>
IOP3A	<input type="text"/>	60	<input type="text"/>	60	<input type="text"/>
RPM ^[1]	<input type="text"/>	20	<input type="text"/>	20	<input type="text"/>
SIGA-UM, -MAB ^[3]	<input type="text"/>	2	<input type="text"/>	17	<input type="text" value="17"/>
Totals			<input type="text"/>		<input type="text"/>

Notes

[1] Add 0.7 mA for each output used.

[2] This represents the smoke power requirements. Only the SIGA-UM or SIGA-MAB that signaled the alarm draws alarm current. The remaining SIGA-UMs or SIGA-MABs do not.































Summary

This appendix contains a set of barcodes that you can use to add location messages.



















Content

Uppercase letters • B.2
Numbers and ordinals • B.2
Common words • B.3



















Uppercase letters

 A	 B	 C	 D	 Backspace
 E	 F	 G	 H	 Delete
 I	 J	 K	 L	 Enter
 M	 N	 O	 P	
 Q	 R	 S	 T	
 U	 V	 W	 X	
 Y	 Z	 Space		





















Numbers and ordinals





















 1	 2	 3	 4	 Backspace
 5	 6	 7	 8	 Delete
 9	 0			 Enter
 1ST	 2ND	 3RD	 4TH	
 5TH	 6TH	 7TH	 8TH	
 9TH	 0TH			

Common words





















ABORT	
ABOVE	
ALARM	
APARTMENT	
APT	
AREA	
ATRIUM	
AUDITORIUM	
BASEMENT	
BELOW	
CAFETERIA	
CEILING	
CLASSROOM	
CLOSET	
COMPUTER	
CONFERENCE	
CORRIDOR	
DAMPER	
DETECTOR	

Barcode library

DOOR	
DUCT	
EAST	
ELECTRICAL	
ENTRANCE	
EXIT	
FAN	
FAULT	
FIRE	
FIRE PUMP	
FLAME	
FLOOR	
FOYER	
GARAGE	
GENERATOR	
GYM	
HALL	
HEAT	
HORN	
JANITOR	

KITCHEN	
LAB	
LEFT	
LEVEL	
LIBRARY	
LOBBY	
LOWER	
MACHINE	
MECHANICAL	
MENS	
MEZZANINE	
MONITOR	
NORTH	
OFFICE	
PARKING	
PENTHOUSE	
PULL	
RELAY	
RESTROOM	
RIGHT	

Barcode library

ROOM	
SECURITY	
SHAFT	
SMOKE	
SOUTH	
STAGE	
STAIRWELL	
STOCKROOM	
STORAGE	
STROBE	
SUITE	
SUPERVISORY	
TROUBLE	
UNDER	
UPPER	
UTILITY	
WAREHOUSE	
WATERFLOW	
WEST	
WOMENS	

ZONE



Summary

This appendix provides information on how to program the SIGA-REL using the QuickStart Configuration Utility

Content

Application block diagram • C.2
Programming instructions • C.3

Application block diagram

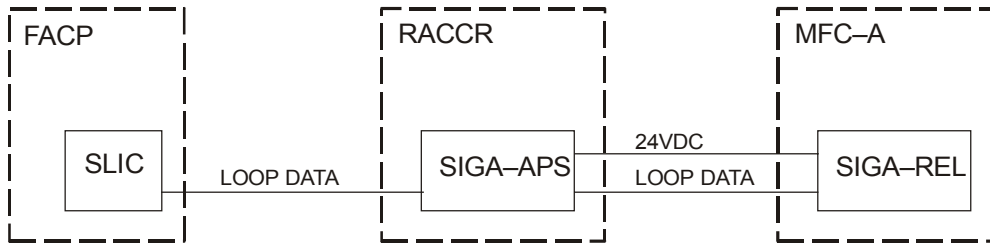

Minimum system requirements

- A QS1 with SLIC card and appropriately sized standby batteries
- A SIGA-APS mounted in an RACCR enclosure with appropriately sized standby batteries to supply 24 Vdc to the SIGA-REL
- A SIGA-REL mounted in an MFC-A enclosure

Caution: You can not have more than 10 SIGA-RELS on one loop.

Related documentation

Refer to the SIGA-REL Technical Reference Manual (P/N 387348) and the latest technical bulletins for installation and connection information.

Refer to the SIGA-APS installation sheet for installation and connection information.

Refer to the RACCR installation sheet for installation information.

Programming instructions

Read me first

WARNING: Attempting to program this application without a complete understanding of the operation of the SIGA-REL, the latest technical information, and the consequences of exposing someone to fire suppression agents may cause personal injury, event death.

WARNING: Improper application of fire suppression agents can lead to property damage, serious injury, or loss of life. Consult the applicable NFPA documents and the local authority having jurisdiction (AHJ) for more information.

WARNING: Disabled and Service Group points will not prevent activation of the release circuits.

This application requires the operation of at least two automatic detectors to activate the fire suppression system. In order to meet NFPA 72 requirements, you must program an And group with at least two smoke detectors and a minimum activation count of 2. The smoke detectors must have their Primary and Alternate Verification properties set to None.

The SIGA-REL has six addressable circuits. To add the SIGA-REL to the loop controller database you must add three SIGA-RELS. The first SIGA-REL is for the Abort switch and Manual Release switch circuits, the second for the two release circuits, and the third for the two prerelease circuits.

Perform these instructions in order from beginning to end. Check the check box provided as you complete each step.

As a safety precaution, disconnect releasing devices from SIGA-REL TB4 before downloading setup data to the loop controller.

Add the Abort and Manual Release Switch circuits

Note: Enter the information exactly as shown to ensure that you program the application according to manufacturer's specifications.

1. Click Configure, then click Cabinets.
2. Select the SLIC connected to the SIGA-REL then click Configure.
3. Click the Modules tab, then set the Quantity box to 1.
4. Enter the following information:
 - Device Type: **Monitor**
 - Model: **REL**
 - Personality: **(3) Active B**
 - Message Specification: **SIGA-REL1 A001** and **ABORT SW**
 - 2nd Device Type: **Pull**
 - 2nd Personality: **(1) Alarm B**
 - 2nd Message Specification: **SIGA-REL1 A002** and **MAN RELEASE SW**
5. Click Add.

□ Add the the two releasing circuits

1. Set the Quantity box to **1**.
2. Enter the following information:
 Device Type: **Output**
 Model: **REL**
 Personality: **(16) Output B**
 Message Specification: **SIGA-REL1 A003** and **RELEASE 1&2**

 2nd Device Type: **Monitor**
 2nd Personality: **(0) None**
 2nd Message Specification: **SIGA-REL1 A004** and **NOT USED**
3. Click Add.

□ Add the two prerelease circuits

1. Set the Quantity box to **1**.
2. Enter the following information:
 Device Type: **Output**
 Model: **REL**
 Personality: **(16) Output B**
 Message Specification: **SIGA-REL1 A005** and **PRERELEASE 1&2**

 2nd Device Type: **Monitor**
 2nd Personality: **(0) None**
 2nd Message Specification: **SIGA-REL1 A006** and **NOT USED**
3. Click Add.

This is how your entries in the Modules table should look. Your addresses may be different.

Address	Serial Number	Device Type	Model	Text 1	Text 2	Personality
126		Monitor	REL	SIGA-REL1 A001	ABORT SW	(3) Active B
127		Pull	REL	SIGA-REL1 A002	MAN RELEASE SW	(1) Alarm B
128		Output	REL	SIGA-REL1 A003	RELEASE 1&2	(16) Output B
129		Monitor	REL	SIGA-REL1 A004	NOT USED	(0) None
130		Output	REL	SIGA-REL1 A005	PRERELEASE 1&2	(16) Output B
132		Monitor	REL	SIGA-REL1 A006	NOT USED	(0) None

❑ **Create a response that activates the prerelease circuits when any one detector in the protected area signals an alarm**

1. Click Configure > Correlations
2. Click the Zones tab, then click Add Zones.
3. Click the Members tab, then click Add Device.
4. Select only the devices required to activate the SIGA-REL prerelease circuits then click OK.
5. Click the Responses tab, click the Response Type arrow, and then select Active.
6. Click Outputs, select the device labeled SIGA REL1 A005 PRERELEASE 1&2, and then click OK.

❑ **Create a response that activates the release circuits when two or more detectors in the protected area signal an alarm**

Note: To comply with NFPA 72, you must program an And Group with at least two smoke detectors and a minimum activation count of 2. The smoke detectors must have their Primary and Alternate Verification properties set to None (verified smoke detectors not allowed).

1. Click the And Groups tab, then click Add AND Group.
2. Set the Activation Count box for 2.
3. Click the Members tab, then click Add Device.
4. Select only the detectors required to activate the SIGA-REL release circuits then click OK.
5. Click the Responses tab, click the Response Type arrow, and then select Active.
6. Click Delays
7. In the Delay On list, click Activation and Restoration.
8. Set the Seconds box to 10.
9. Click Outputs, select the device labeled SIGA REL1 A003 RELEASE 1&2, and then click OK.

❑ **Create a response that activates the release circuits when someone presses the manual release switch**

1. Click the Devices tab, then select the circuit labeled SIGA-REL A002 MAN RELEASE SW.
2. Click the Responses tab, click the Response Type arrow, and then select Active.
3. Click Outputs, then:
 Hold the Ctrl key down
 Select the device labeled SIGA REL1 A005 Prerelease 1&2
 Select the device labeled SIGA REL1 A003 Release 1&2
 Release the Ctrl key then click OK.

Note: The prerelease circuit must appear before the releasing circuit in the response list.

□ Create a response that activates the prerelease circuits when someone presses the Drill switch

Note: Create this response only if required. Pressing Drill will activate the prerelease circuits but pressing Drill a second time will not restore the prerelease circuits. You must press Reset to silence the prerelease circuits.

1. Click the Devices tab then select the Show Pseudo Points check box.
2. Select the circuit labeled Drill (address 007).
3. Click the Responses tab, click the Response Type arrow, and then select Active.
4. Click Outputs, select the device labeled SIGA REL1 A005 PRERELEASE 1&2, and then click OK.

□ Retrieve the loop data from the SLIC

1. Click Configure, then click Cabinets.
2. Select the SLIC connected to the SIGA-REL then click Configure.
3. Set the Communications Port setting for the COM port used to connect the service computer to the control panel.
4. Click Retrieve Signature Data
5. After the upload has finished, click OK.

□ Reconcile the actual and expected data

Caution: Clicking Accept Actual will enter the selected device into the database with its current programmed parameters. This will corrupt the database if you have already entered the device.

1. Click the Mapping tab, then click Model.
2. Look for a string of at least six RELs marked with red backgrounds and double-click the first REL in the string.
3. If the serial number displayed in the Module Properties dialog is not the same as the serial number shown on the bar code attached to the SIGA-REL, click Close, and then double-click the next REL in the string.
4. If the serial numbers are the same:
Click Select Expected.
In the Module Selection dialog, select the row that has the REL with the Monitor device type and marked SIGA-REL1 A001 Abort SW, then click OK.
Click Close.
5. Select the next REL then click Select Expected.
In the Module Selection dialog, select the row that has the REL with the Output device type and marked SIGA-REL1 A003 Release 1&2, then click OK.
Click Close.
6. Select the next REL then click Select Expected.
In the Module Selection dialog, select the row that has the REL with the Output device type and marked SIGA-REL1 A005 Prerelease 1&2, then click OK.
Click Close.

- **Send the reconciled data to the loop controller** Click the Controller tab, then click Send Signature Data.

